



# Leica DMI4000 B Leica DMI6000 B

Automated Inverted Microscopes for Life Sciences

Living up to Life

*Leica*  
MICROSYSTEMS

Intelligence  
Brilliance  
Integration  
Flexibility

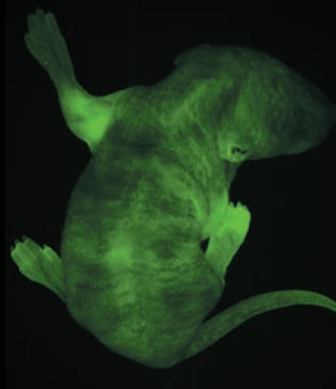
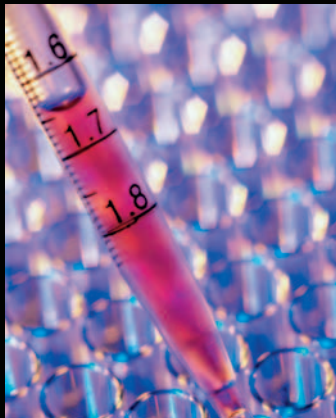

Photo: IGBMC, Strasbourg, France

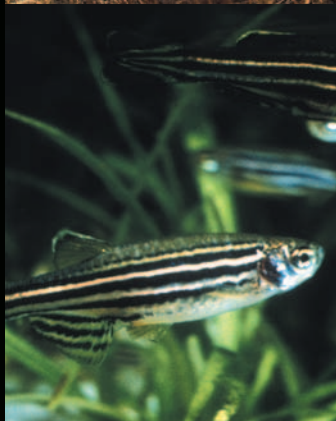

Photo: ZFIN <http://zfin.org>

# The Standard in “Intelligent” Inverted Digital Microscopy

Leica Microsystems developers apply a wealth of experience to help you present your research with the best possible image quality. The Intelligent Automation of the new Leica DMI series inverted microscopes will show you the meaning of enjoying your work. Using a microscope has never been this easy. You can depend on an optimized system using the Leica DMI microscope.

## Intelligent imaging – at the touch of a button

The intelligence of the Leica DMI series is impressive. It couldn't be easier to capture outstanding images. With its Contrast, Illumination and Stability Manager, the DMI microscope series ensures razor-sharp, brilliant images at the touch of a button.

## Experience and innovation – the art of creating brilliant images

Experience Leica's new fluorescence axis that offers everything you expect from a light microscope in terms of brilliance and resolution. The DMI microscope also features an unparalleled innovation – the ultra-fast Leica IFW Integrated Filter Wheel.

## A team is more powerful than the individual players

Leica products are team players that are carefully attuned to one another and reinforce each other's strengths. The Leica product line ranges from microscopes to digital cameras and software solutions for a variety of applications. Assemble your ideal system from the Leica product range – all of the components interact seamlessly.

## Adaptable, yet individual

Your research is unique and the microscope you use should be as well. Leica cooperates closely with accessory manufacturers for that reason. As a result, the system is designed so that any accessory you need will integrate reliably with the Leica DMI inverted microscope.

---

We would like to thank IGBMC, Strasbourg, France, for its kind support in the creation of many application images.



Leica Design by Christophe Apothéloz

# Leica DMI Inverted Microscopes for your Applications

Are your research activities multifaceted? Innovative? The Leica DMI inverted research microscope series has an ideal solution for every application. Choose from the DMI3000 B, DMI4000 B and DMI6000 B models. The DMI family includes fully automated and coded microscopes. Leica also offers a completely manual stand for cost-conscious users: The DMI3000B is available with or without fluorescence. If you frequently work with micromanipulation and require an ergonomically designed system, you will be thrilled by the DMI3000 B\*.



## Leica DMI: Intelligent Automation

All Leica DMI models feature “Intelligent Automation” so that the user can concentrate on the experiment, not on microscope functions. Whether you prefer a fully automated version or a coded microscope – Leica’s intelligent digital technology is yours either way! All instruments feature the common bright field, phase contrast, dark field, DIC (Differential Interference Contrast) and polarization transmitted-light methods as standard. Leica’s new IMC (Integrated Modulation Contrast) option is also available for all instruments.

All microscopes for fluorescence methods support combination contrast and an automated fluorescence axis with all its advantages: motorized 6-position turret, FIM, IFW and ExMan at the touch of a button as standard. The side camera ports are also motorized as standard. The ergonomic tube also belongs to the standard features of the microscope.

## Leica DMI4000 B

The DMI4000 B is a premier-class research microscope. With its manual focus and manual, coded objective turret, this microscope is the entry into the research class. At the same time, many upgrades are available to keep all of your options open for challenging research tasks in the future. For example, the fluorescence axis, additional lateral camera ports, and motorized magnification changer can be added – upgrading by addition of these accessories is possible at any time. You can also buy stages, condensers and lamp housings for your microscope whenever you need them.



\* Also see the Leica DMI3000 B product brochure.

### Leica DMI6000 B

The DMI6000 B offers the capabilities of full automation. With a motorized focus and objective turret as standard features, you can take advantage of a fully automated instrument that can be controlled completely from your PC, right down to the fine adjustment of the DIC prisms. All of the accessories available for the DMI4000 B can also be used with the DMI6000 B. The microscope thus grows to meet your requirements.



### Configurations:

		DMI3000 B	DMI4000 B	DMI6000 B	
Stand	Focus	Manual	Motorized	Motorized	
	Objective turret	Manual	Coded	Motorized	
	Magnification changer	Manual	Manual	Motorized	
Transmitted light	Illumination arm	Manual	Motorized	Motorized	
	Condensers	Manual	Coded	Motorized	
	Transmitted-light methods	BF	Manual	Coded	Motorized
		PH	Manual	Coded	Motorized
		DF	Manual	Coded	Motorized
		DIC	Manual	Coded	Motorized
		POL	Manual	Coded	Motorized
IMC	Manual	Coded	Motorized		
Fluorescence	Fluorescence axis	Manual	Motorized	Motorized	
	Combination contrast	PH/Fluo	Manual	Coded	Motorized
		DIC/Fluo	Manual	Coded	Motorized
Camera ports	upper	Manual	Manual	Manual	
	side	Manual	Coded	Motorized	
	bottom	Manual	Manual	Motorized	

motorized
  coded
  manual

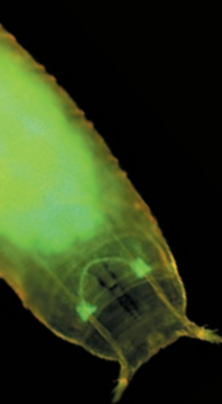



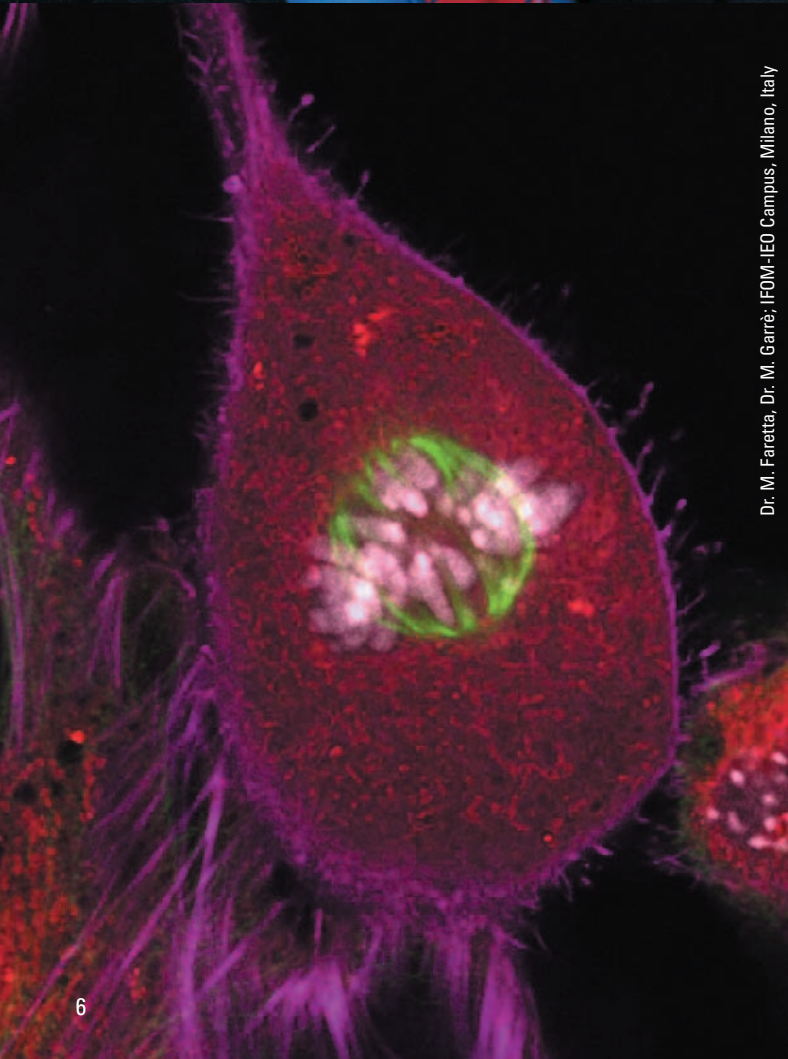
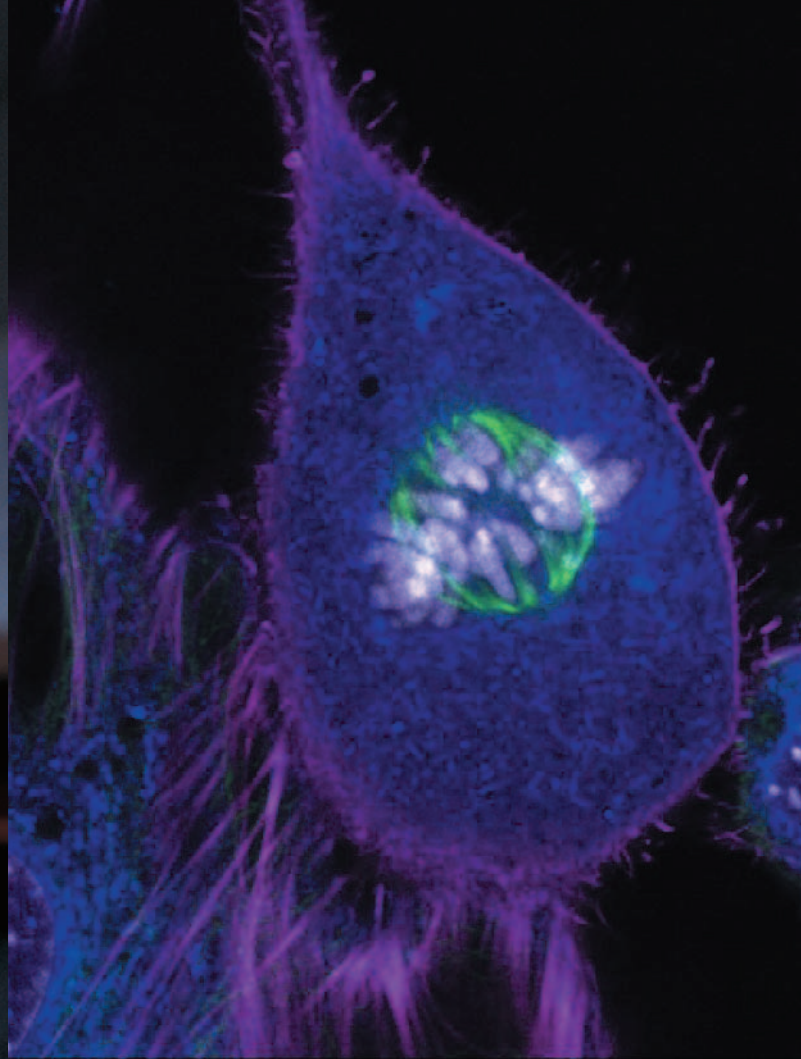

Dr. M. Faretta, Dr. M. Garre; IFOM-IEO Campus, Milano, Italy

“The term ‘Intelligent Automation’ doesn’t refer to the simple motorization of individual elements. For Leica, it means the smooth, well-rounded automation of all functions. For users, it means they can focus on their actual work rather than on operating the microscope.”

**Oliver Jagemann, DMI microscope project leader, Leica Microsystems**

# Intelligent Imaging – At the Touch of a Button

## Let there be light

Change the objective, and readjust the brightness and diaphragms. How many times a day do you do that? As of now, it's history! The Leica DMI Illumination Manager handles it for you reliably. When changing magnification or contrast technique, it automatically sets the brightness, aperture, and field diaphragm to their optimal values. And if you have special requirements regarding the settings, then simply adjust them and the microscope will adopt them immediately.

## Less for more

What's more, the light intensity control can also be used for fluorescence. The Leica FIM (Fluorescence Intensity Manager) regulates light intensity at five fixed levels – and remembers the setting for each filter cube.

## Like a rock

Microscope stands are made of metal. When metal warms up, it expands and that's a law of physics that can't be circumvented. But it doesn't have to interfere with your work. Long-term measurements can take hours or even days, and it's important that the selected focal plane remains in the same place during the entire experiment. The expansion of a metal stand can affect this adversely. The Leica DMI6000 B is equipped with Stability Manager temperature drift optimization that reduces drift in the z axis to a minimum.



### Illumination Manager

The Leica Illumination Manager for custom diaphragm and light settings is located on the left side of the instrument. Switching between transmitted light and the fluorescence axes is simply a matter of touching a button. Each change is automatically stored and displayed.

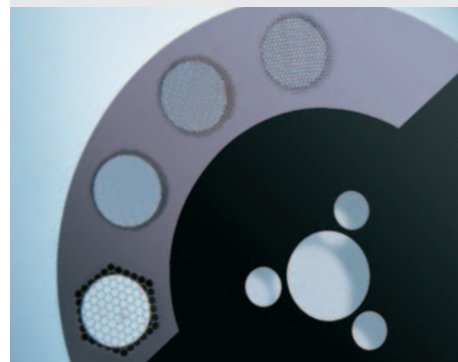

### Fluorescence Intensity Manager (FIM)

The FIM disk is located in the aperture diaphragm plane of the fluorescence axis. It features stop plate disks of varying transmissivity for improved homogeneity and excitation brightness control. The regulation takes place in five fixed steps: 100%, 55%, 30%, 17% and 10%.



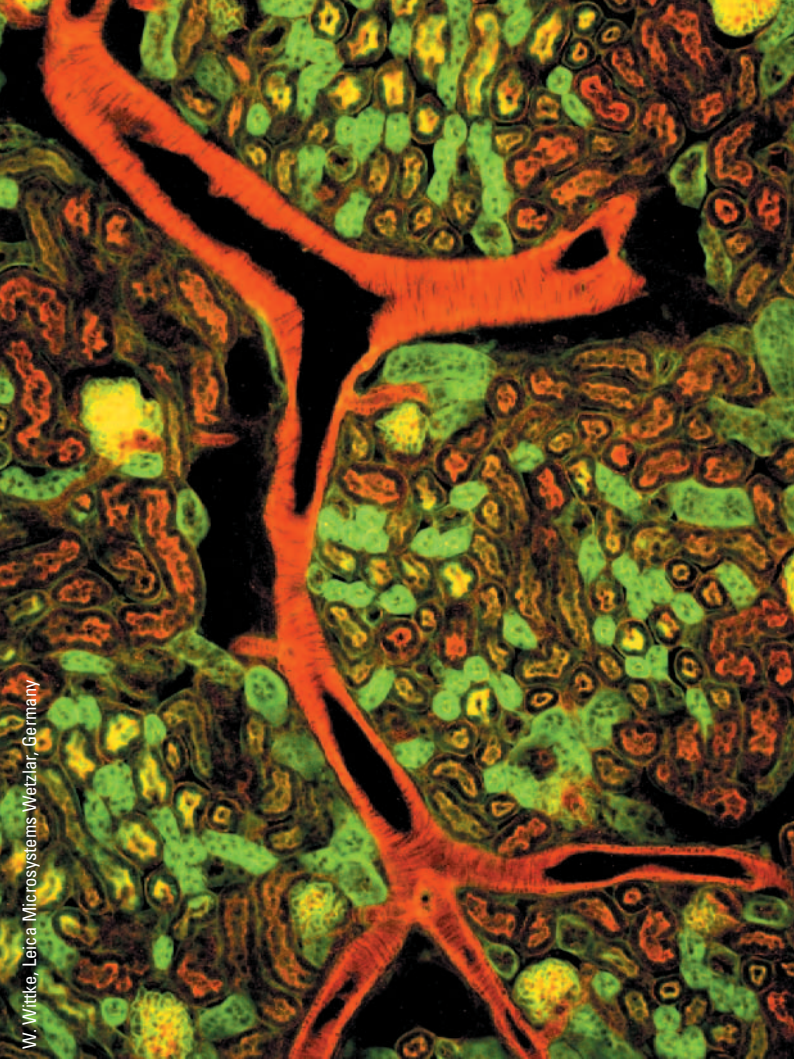

W. Wittke, Leica Microsystems Wetzlar, Germany



“The long-term observation of living samples is an important tool for researchers exploring cell processes. With the Stability Manager, Leica has created the preconditions for minimizing thermal expansion of the instrument to ensure the value and comparability of your findings. Consistent razor-sharp images are the result during long time-lapse measurements.”

**Bernard Kleine, DMI Series Product Manager, Leica Microsystems**

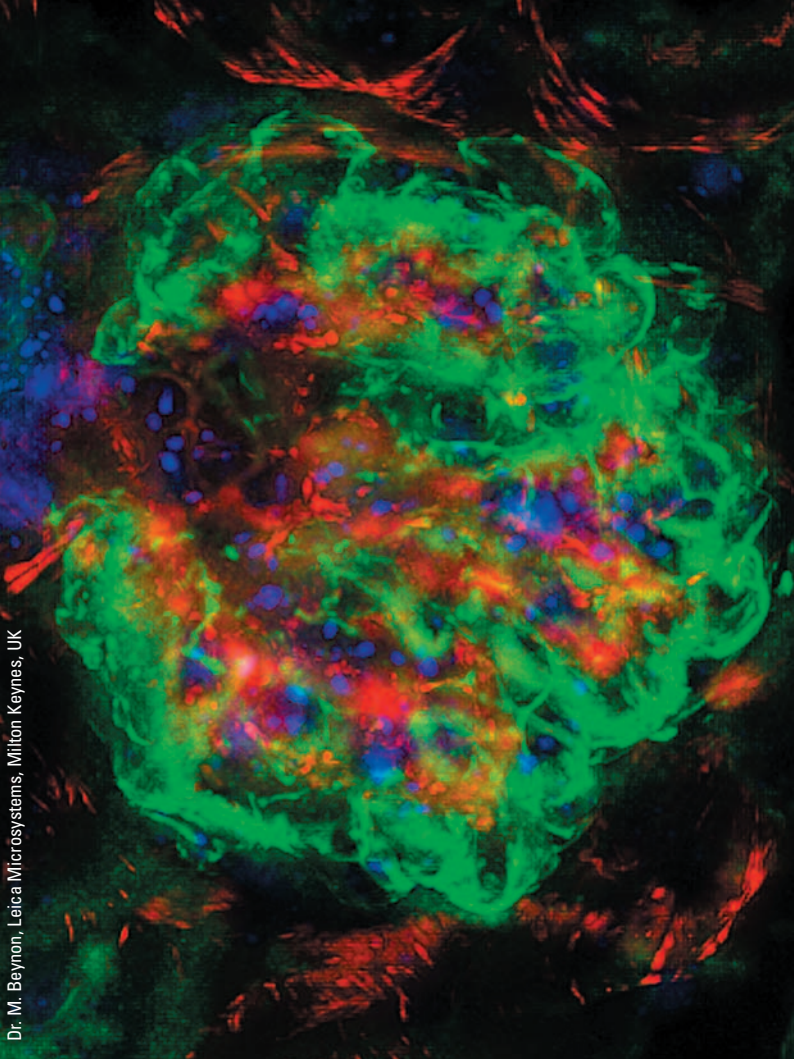

Dr. M. Beynon, Leica Microsystems, Milton Keynes, UK



# Intelligent Imaging – At the Touch of a Button

## Contrast – as if by magic

The days of adjusting condensers are over. With the Leica DMI series, simply press the “PH” button and phase contrast sets automatically. The microscope knows the correct phase ring for each objective and positions it into the beam path. Differential interference contrast is even more astonishing: At the touch of a button the analyzer, polarizer, and the correct prism pair for the objective automatically swing into the beam path. Changing contrast techniques is that simple – whether transmitted light or fluorescence – all it takes is the touch of a button.

## Supports a variety of control methods

The new, external Leica STP6000 SmartTouch Panel offers a new level of operational freedom to the researcher. All automated microscope functions can be conveniently and intuitively set from anywhere within the workspace via the external control, which provides the same graphical user interface as Leica Application Suite (LAS) software. Also, the Leica SmartTouch Panel offers a focus wheel for fine and coarse adjustment, controls for x, y stage adjustment, and eleven programmable function buttons. This allows easy and convenient control of all functions using one module. Alternatively, the user can control all three axes of the microscope (x and y: stage; z: focus) with the Leica SmartMove remote control and program four function buttons to control additional microscope functions.



## New condenser generation

A new generation of coded manual and motorized condensers is available for the DMI series.

This range of condensers is the first ever to support magnifications of 1.25x to 100x in inverted microscopes. Another new feature is the plug connection between the condenser and illumination arm, making condenser replacement easy. And thanks to the Koehler locking lever, users can store their optimal Koehler settings; the lock also prevents damage to manipulation needles.

The aperture diaphragm integrated in all of the condensers is available in manual and motorized versions for optimal Illumination Manager support. All condensers feature septuple condenser disks, making them suitable for all contrast methods.

A variety of condensers are available for working distances from 1 to 70 mm. The S1-28 condenser base is suitable for working distances from 1 to 28 mm. It can be equipped with a variety of condenser heads that swing out for low magnifications. The S70 condenser base is equipped with a fixed condenser head for a working distance of 70 mm.

# Long-Term Measurements

The system shown below consists of a Leica DMI6000 B with a Leica DFC360 FX digital fluorescence camera and Leica AF6000 fluorescence application software. This system is specifically designed for long-term fluorescence observation.

## Leica DMI6000 B:

- The Parfocality Manager provides a sharp image at all times – even after changing the magnification.
- The automated fluorescence axis supports full remote control.
- Together with the integrated shutter, the IFW provides fast wavelength changes when using fluorescence methods.
- Bulky cameras can be connected to the bottom port.

## Accessories:

- The flat climate chamber (Incubator SM or Incubator S) can be equipped with a heating insert.
- The CTI Controller 3700 regulates the CO<sub>2</sub> supply during the entire experiment.
- The Tempcontrol unit monitors the temperature.

## Leica DFC360 FX:

- The digital camera features a FireWire port for fast image transfers.
- The cooled monochrome chip provides the highest resolution and noise reduction when using fluorescence methods.

## Leica AF6000:

- The AF6000 is the perfect software solution for the execution of time-lapse experiments and capture of AVI videos.
- Excellent control of the Z axis from within the AF6000 results in easy acquisition of 3D data sets.

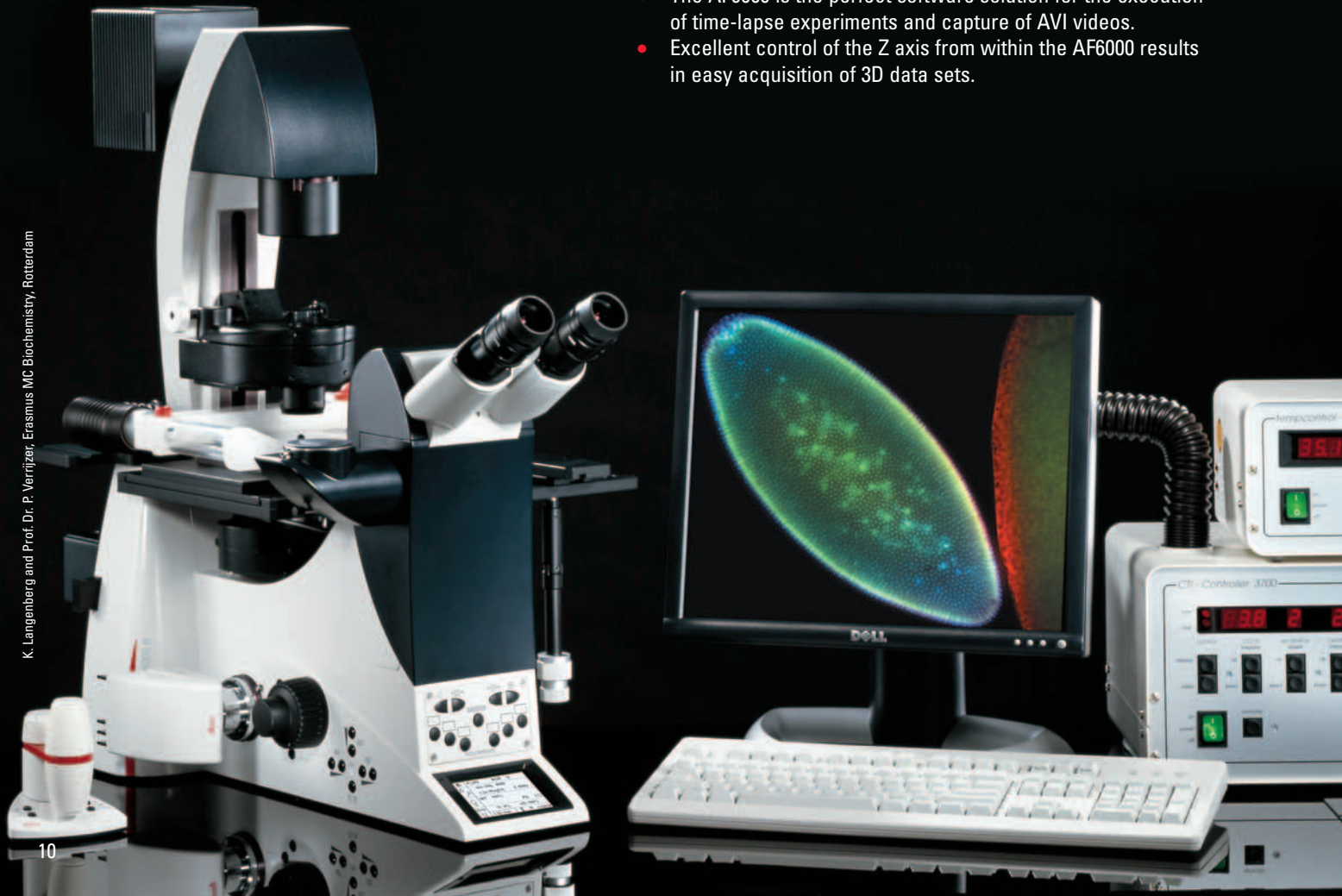

# Intelligent Imaging – At the Touch of a Button

## MYcroscopy

The Leica DMI series offers seven to eleven freely programmable buttons to operate the functions most important to you. Use them to create your own microscope – put the functions you need wherever you want them.

## Once in focus – always in focus

The Leica DMI6000 B's motorized z focus and parfocality function are special highlights. Objective sets are designed to ensure that the focal planes of individual objectives always lie in the same z plane. If minor deviations arise due to production tolerances, it may be necessary to correct the focus after changing objectives. In this case, the parfocality function compensates for different focal planes. In addition, the focal plane and an additional lower plane can be saved and restored automatically.

## A clear view, wherever you look

The graphical display has been structured so that you can view it with a quick glance. It cannot be obscured, even when using large climate chambers. The current status of the microscope is always visible.



## Status display

All microscope settings at a glance: the current contrast method, selected magnification, illumination parameters and camera ports, as well as information on the focal plane are all available.

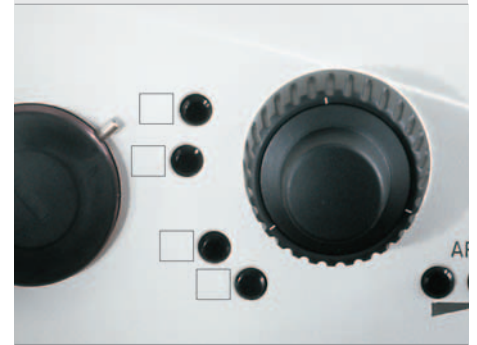

## Free programming

Four of the freely programmable buttons are located on the left side of the microscope. Three additional buttons on the right side of the microscope and four on the SmartMove\* remote control complete the selection. Each of these buttons can be programmed without restrictions to perfectly configure the microscope to your requirements.



## Focus Manager\*

The Focus Manager, which stores, deletes, and travels to two focal planes, is located on the right side of the microscope. In addition to storing the focal plane, a further, lower level can be stored to ensure reliable objective changing, even with complex stage setups.

\* Available for the Leica DMI6000 B.



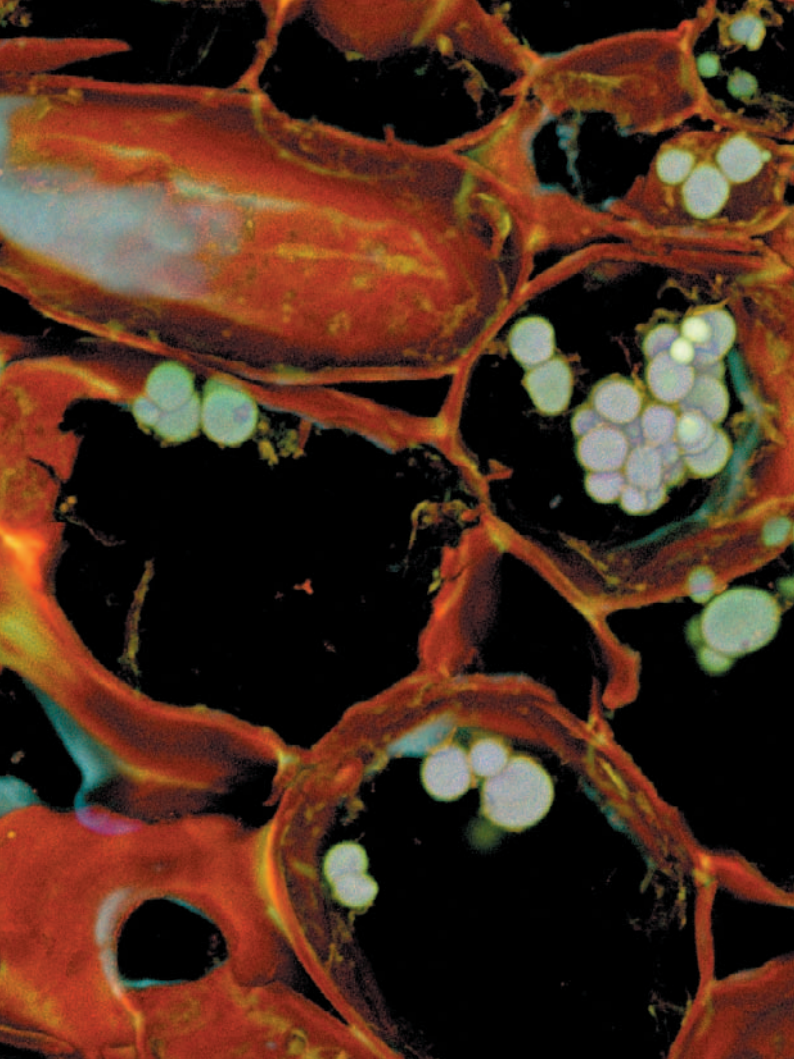

“With regard to optical performance, the Leica DMI series sets completely new standards. That not only applies to the dramatically improved DIC. The fluorescence is also more brilliant than ever thanks to new developments such as Leica’s Light Trap, Excitation Manager, and Integrated Filter Wheel.”

**Peter Euteneuer, Manager, Optical System Planning, Leica Microsystems**

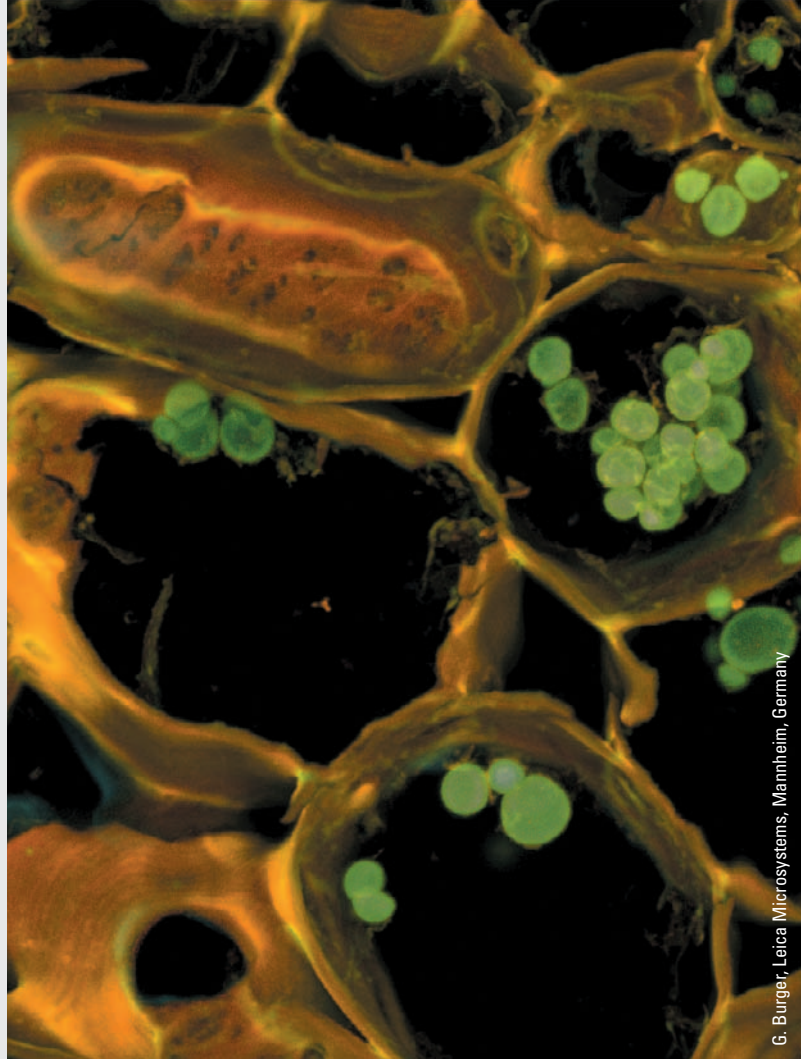

# Experience and Innovation – The Art of Creating Brilliant Images

## **Contrast and resolution for every specimen –**

### **Leica's new DIC (Differential Interference Contrast)**

It's a familiar phenomenon when using DIC: improved contrast results in lower resolution and vice versa. This effect is more pronounced when observing specimens that are unusually thick or thin. Leica offers special prism combinations for such cases: Prism C for regular thickness, C1 for especially thick, and C2 for especially thin specimens.

The unique Leica DIC is the first and only DIC to be fully motorized and completely automated. After choosing the objective, the microscope automatically activates the correct compound prism, polarizer and analyzer.

Even the DIC's bias adjustment is motorized. The microscope stores the fine adjustment for each objective and restores it automatically. It's simply the fastest, most reliable way to set up DIC.

## **Take the optics into your own hands –**

### **New integrated Modulation Contrast (IMC)**

Leica optics experts have created an integrated interpupillary interface. Leica's IMC provides modulation contrast in complete perfection, with brightfield objectives – an optical stroke of genius that's easy on the budget.

## **Why settle for less? –**

### **New integrated Phase Contrast (IPH)**

If you can realize modulation contrast with bright-field objectives, you shouldn't have to buy special objectives for phase contrast. Leica has applied the integrated interpupillary interface to another revolutionary phase contrast method, IPH. It's the first phase contrast in which you can influence the contrast yourself – also with bright-field objectives.

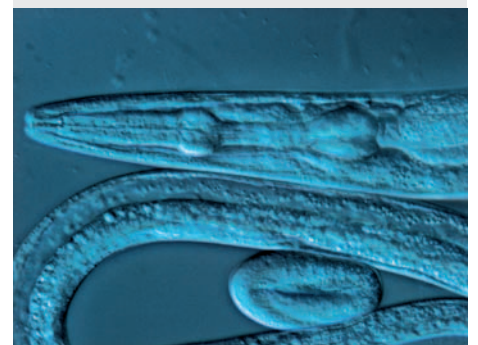

*C. elegans* recorded with DIC and Wollaston prisms with different splitting angles.

Image source: IGBMC, Strasbourg (F)



# Experience and Innovation – The Art of Creating Brilliant Images

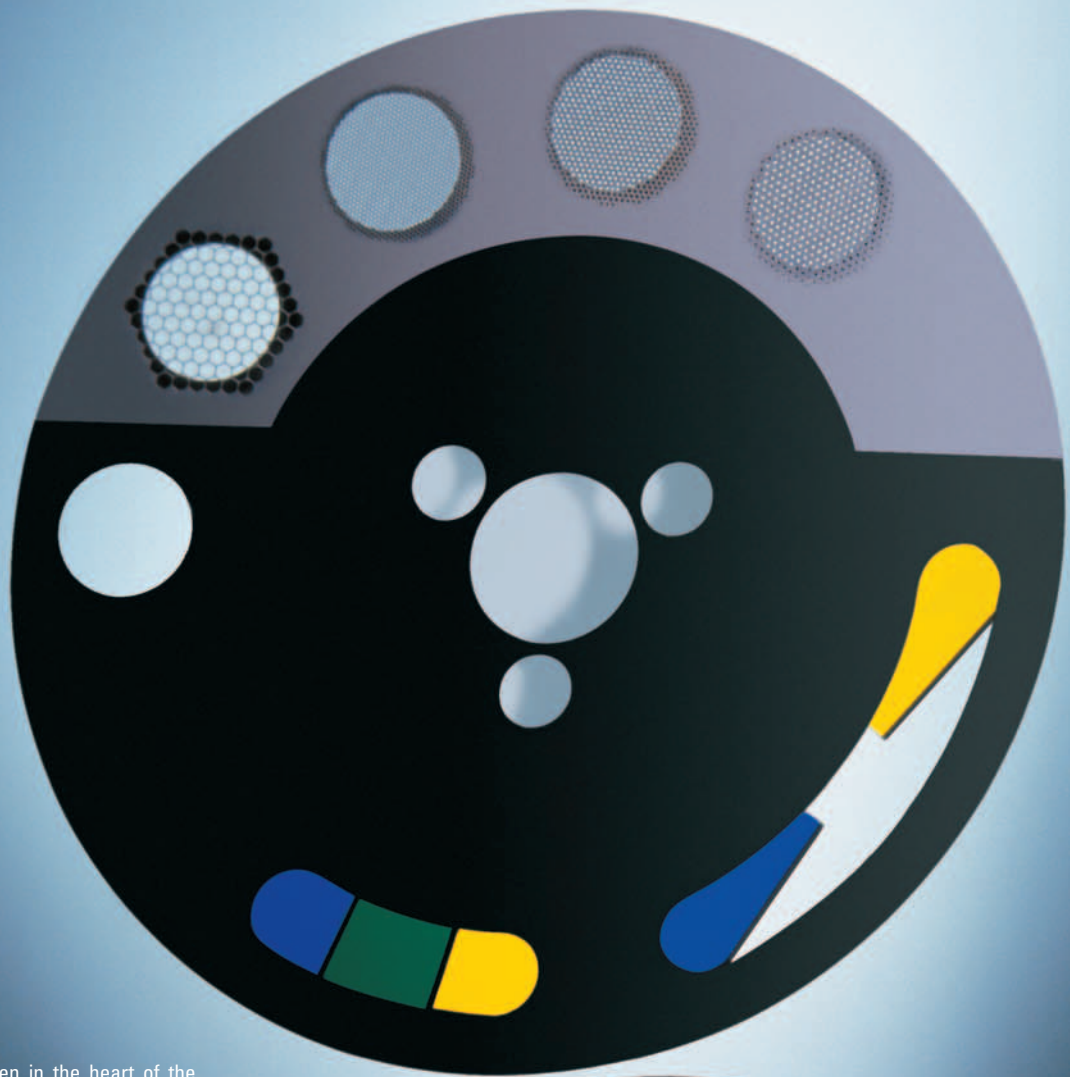

## A disk like no other

This all-round genius is hidden in the heart of the fluorescence axis. Leica engineers have put the FIM (Fluorescence Intensity Manager), 2 fast shutters, motorized Excitation Manager, and IFW (Internal Fast Filter Wheel) on a disk with a diameter of 49.5 mm.

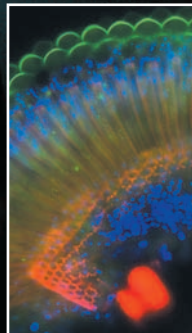
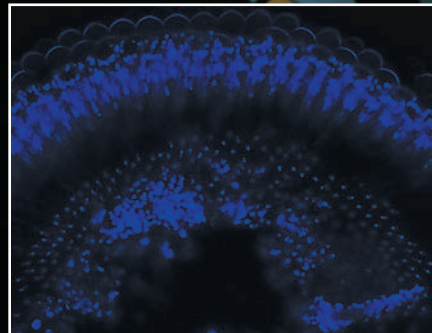
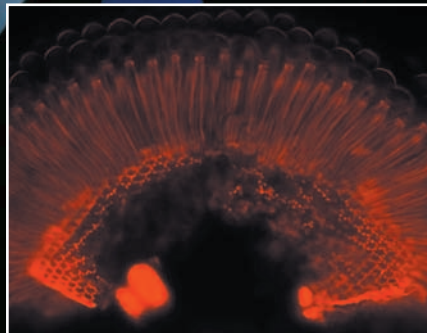
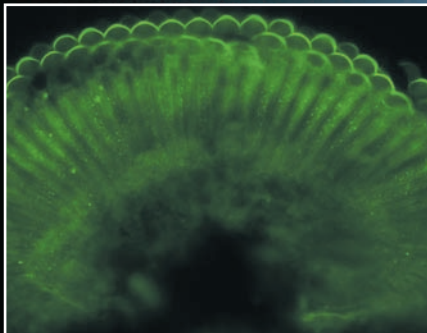

*Drosophila* eye – FITC, CY3, DAPI, BGR



**Black as night**

A fast shutter is essential for most fluorescent observations. Leica DMI microscopes integrated shutters will automatically interrupt the excitation in less than 0.1 seconds, essential for optimal protection of your specimen.

**Colorful as the rainbow**

Multiple excitations are used in modern fluorescence microscopy to make a variety of cell compartments visible simultaneously. However, it's equally important to be able to observe the various stains individually. Until now, conventional microscopes required multiple fluorescence filters to realize this. With the Leica DMI microscopes, this is now possible with a single filter cube: A multi-pass fluorescence filter cube, together with the ultra-fast IFW internal filter wheel, allows the separation of nearly all GFP variants as well as traditional fluorescence stains – and equally fast changeover on the emission side – all within 0.05 seconds.

**Balance is the key – Leica Excitation Manager**

Users can balance the fluorescence intensity of specimens with multiple fluorescent probes, directly at the microscope, using the integrated Excitation Manager. The Excitation Manager is motorized and features 16 levels to selectively enhance red or green fluorescence. The settings can be stored and reproduced whenever needed.

**Blacker background – Leica's Light Trap**

A blacker background leads to more brilliant fluorescence – and that's the principle which led Leica to develop the Light Trap. Multi-band filter cubes contain black glass with highly-polished, low-reflection surfaces that absorb undesirable stray light to provide a perfectly black background.

**Standing firm – Unique Zero Pixel Shift technology**

Only Leica filter cubes feature Zero Pixel Shift technology. It prevents image shifting when observing specimens using different filter cubes. You can accurately superimpose your images – a pixel in an FITC image will be at precisely the same location in a DAPI image. Time-consuming overlay matching is not required.

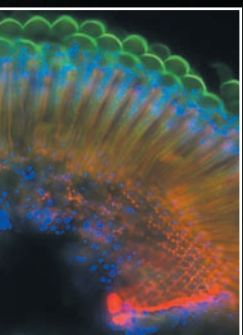

# Fluorescence Observation

Fluorescence observation is standard for viewing living cells. The system below consists of a Leica DMI6000 B, DFC360 FX digital fluorescence camera, and AF6000 fluorescence software. Systems of this type are ideal for recording, archiving and processing fluorescence images.

## Leica DMI4000 B:

- The automated fluorescence axis supports full remote control.
- The 6-position filter cube changer offers enough space for a variety of fluorescence observations.
- The Fluorescence Intensity Manager (FIM) regulates the excitation light to effectively protect your specimens.
- The Internal Filter Wheel (IFW) changes excitation wavelengths in milliseconds.
- The integrated shutter reliably protects specimens against bleaching.
- The Excitation Manager coordinates the intensity of multiple excitations.
- Zero Pixel Shift technology ensures perfect image alignment of multiple excitations, making software overlay compensation superfluous.

## Leica DFC360 FX:

- The digital camera features a FireWire port for fast image transfers.
- The cooled monochrome chip provides the highest resolution and noise reduction when using fluorescence methods.

## Leica AF6000

- Enables fully integrated control of all microscope and camera features.
- Offers unique intuitive graphical user interface
- Leica AF6000 provides a complete set of tools for image enhancements & measurement
- Additional application modules may be added to extend functionality



**Seeing with different eyes – the new fluorescence**

How can you improve on something that’s already outstanding? By studying the smallest details. That’s precisely how Leica optical experts perfected the fluorescence axis of the Leica DMI microscopes. Every single optical component of the fluorescence axis was studied and optimized with regard to transmission, image flattening and light flux qualities. The result is a fluorescence axis of peerless optical quality.

**Another helping?**

The Leica DMI series can accommodate up to six fluorescence filter cubes at a time – more than enough for most studies. And if another filter cube is needed? Replacement is easy: Simply press a button to swing out the filter disk and replace the filter cube with a click. What’s more, the filter disk positions a filter cube into the beam path in less than 0.2 seconds – unparalleled convenience.

**Everything at a glance**

The most important fluorescence functions – filter cube change-over and shutter function – can be monitored at a glance and controlled at the front panel. Feedback is displayed immediately.

**Open for partners**

The diameter of the new fluorescence axis is one inch. It’s therefore ideally suited for peripherals such as shutters or external filter wheels. And, this equipment can be controlled via Leica software solutions.



**Fast filter changing**

Shown is the open drawer of the 6-position filter holder for fluorescence filter cubes. The cover opens at the touch of a button and automatically moves the filter cube into the beam path to the opening. Filter cubes can be replaced in seconds.



**Clearly designed controls**

The most important fluorescence functions are grouped on the front panel. Each filter cube can be controlled directly. The shutter opens or closes at the touch of a button. Feedback is immediately displayed.



**Leica EL6000**

New external light source for fluorescence excitation. The adjustment-free metal-halogenide lamp with its long bulb life saves time, money and energy.



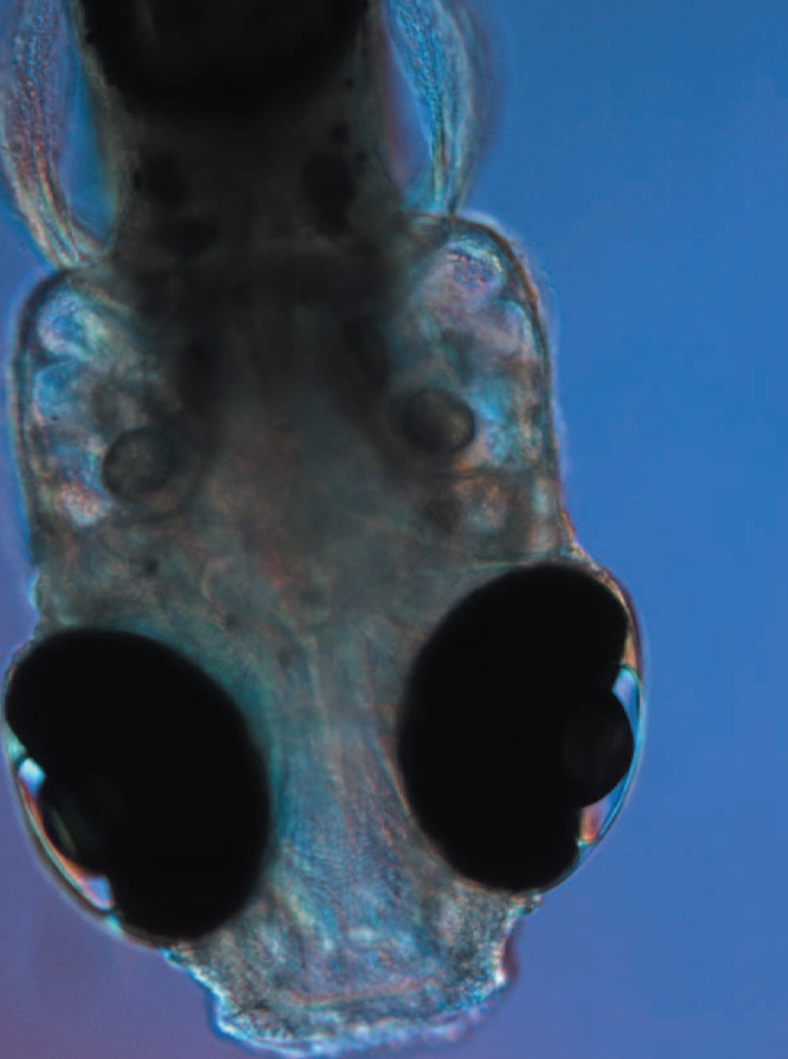

“In the IGBMC service department, 20 users per day use our microscopes. Leica is our one-stop source for cameras, software, and microscopes that are perfectly attuned to one another. Every one of our systems can be configured to suit different researchers with different backgrounds investigating different topics. Leica’s MUP (Multi-User Package) software that stores a variety of user profiles is helpful to us in this respect.”

**Dr. Jean-Luc Vonesch, Computer Scientist, Head of the Imaging-Optical Unit and Confocal Microscopy, IGBMC Strasbourg**

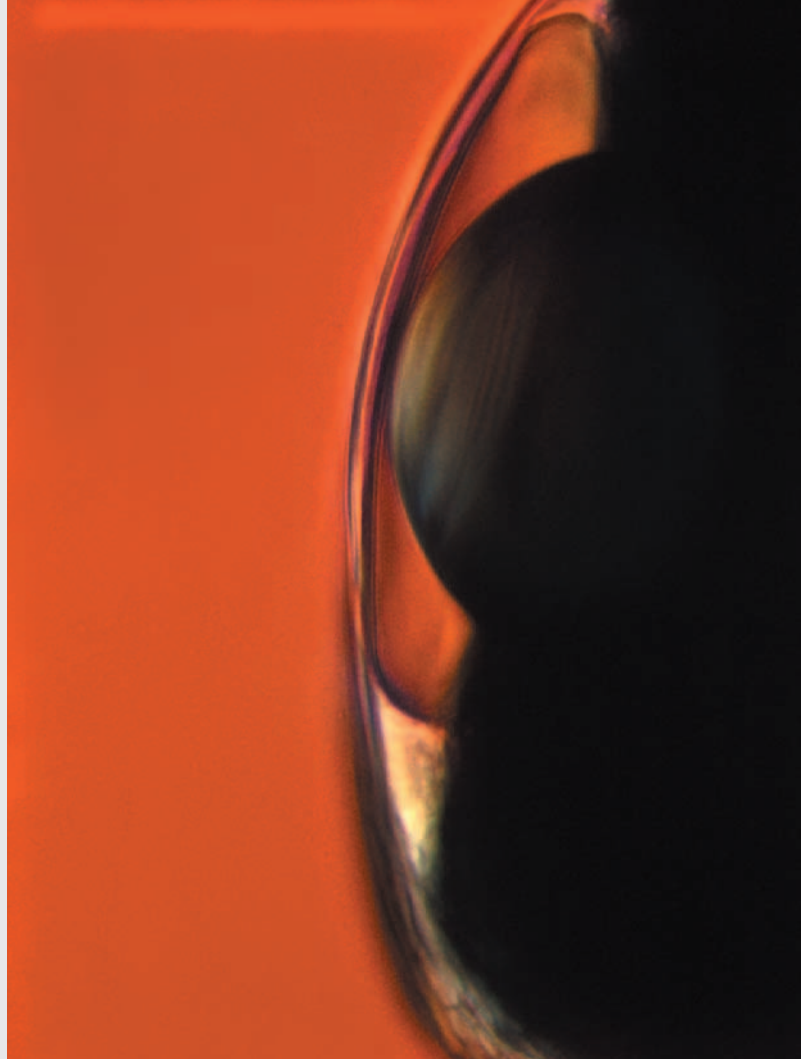

# A Team is More Powerful than the Individual Players

## Leica microscopes – a perfect fit for every user

Microscopes are frequently shared by a number of users, each with different personal requirements. With Leica's MUP (Multi-User Package) software, custom microscope configurations can be created and stored for each user and restored by entering a personal password.

## Repeatable experiments

A typical scenario: An experiment is to be repeated weeks or even months later with new specimens. The images of the different specimens need to be compared. Until now, taking exactly comparable images was virtually impossible. Not so with Leica's new Store & Recall module! This software module stores the complete microscope settings together with the image. To take a new image under the same conditions, pressing a single button restores the old settings, including the light settings for fluorescence and fine adjustment of the DIC!

## Perfect fluorescence analysis software

In cooperation with leading scientists, Leica has developed fluorescence application software that leaves nothing to be desired. The Leica Advanced Widefield Systems link the microscope, camera and peripheral devices, giving an optimal integrated system for use with Leica's inverted, upright and stereo microscopes.

Leica's Advanced Widefield systems start at the entry level with the Leica AF6000E for image documentation, going up to high speed imaging systems, offering real time control for advanced experimentation. The platform has a modular software architecture, with specific modules for applications such as Deconvolution or FRET available as optional extras.

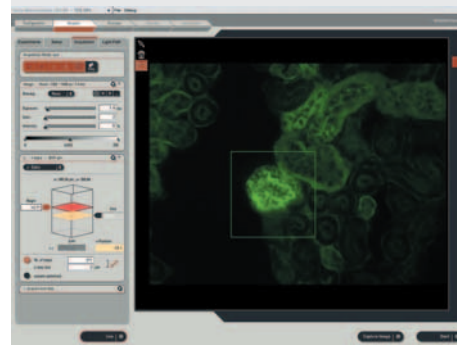

Leica AF6000 image archiving

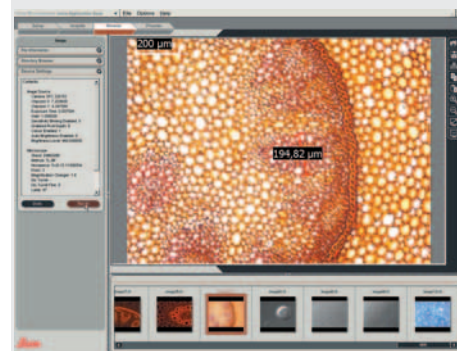

## Store & Recall application module

This module stores a complete set of microscope configuration information together with the application images. The full range of settings can be recalled at the touch of a button as required.

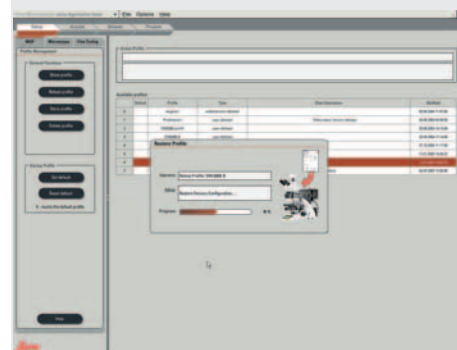

## Multi-User Package (MUP) module

This module supports multiple, password-protected user profiles. Users can thus store and recall their personal configurations.



# Imaging System for Observing Living Cells

Imaging systems are fundamental for recording, processing, and archiving images – ease of use and suitability for universal deployment are essential. The system below consists of a Leica DMI6000 B, Incubator BL and heating unit. Leica recommends the Leica DFC FX camera range, such as the Leica DFC310FX for colour imaging or the monochrome DFC360FX, specifically designed for fluorescence applications. The Leica AF6000 software has been developed especially for fluorescence applications. Users with a wide range of applications are well served by Leica QWIN, with its macro editing capability.

## Leica DMI6000 B:

- The fully automated fluorescence and transmitted-light axes can be fully remote controlled from the PC. Accessing the climate chamber to operate the microscope is not necessary.
- Remote control via Leica SmartMove provides vibration-free conditions.
- The display is located outside the climate chamber and can be read clearly at all times.

## Incubator BL:

- The temperature in the sealed chamber can be held constant at up to 17°C above room temperature.
- Fresh air availability has been optimized with generously-sized ventilation hoses.
- The temperature sensors can be positioned and attached anywhere in the climate chamber.
- Leica's Incubator BL is the only climate chamber that completely accommodates accessories such as Eppendorf manipulators, scanning stages, and 3-plate cross-stages.
- The large access openings are ergonomically shaped and allow convenient access to the instrument inside the chamber.

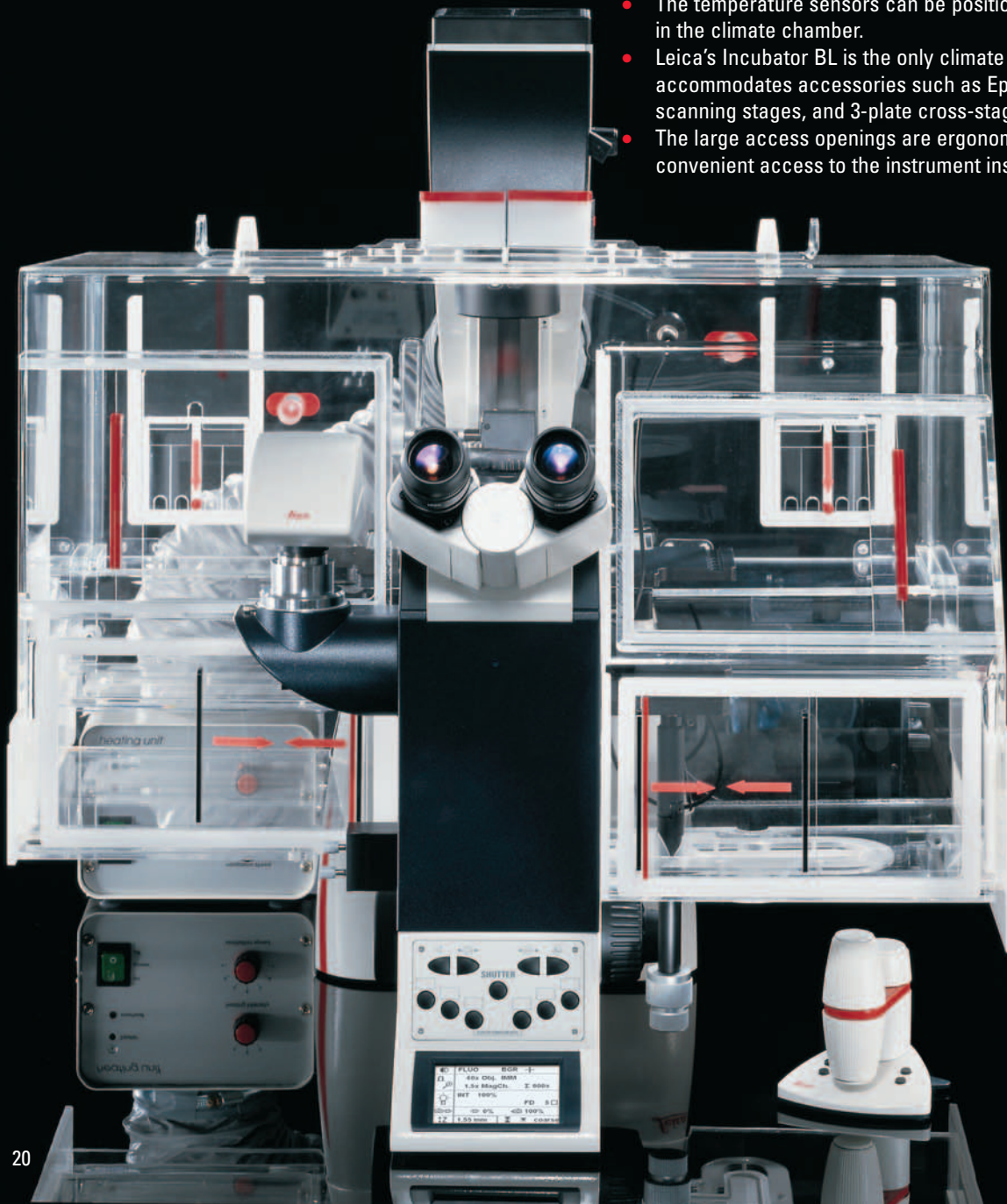



# A Team is More Powerful than the Individual Players

## Four eyes see more than two

One camera for fast live images – one camera for high-resolution fluorescence images – and one for video. While that's not unusual, it frequently poses problems for users. The Leica DMI series features three to four camera ports – a suitable one for any camera type. The motorized bottom port\* is ideal for bulky cameras. Two lateral motorized ports (left and right) round out the selection. Another mechanical port on the tube was developed for systems that do not have room at the sides due to accessories. A special highlight of Leica's camera port program: You can freely choose which ports to use and how much light they will receive. A product palette of 13 different components – prisms with varying degrees of transmissivity and even color splitters – can be combined for more than 200 different camera port configurations – enough to find the ideal solution for your requirements.

## Focus at the touch of a button

The Leica Application Suite offers an Autofocus module for all Leica digital cameras, both documentation cameras such as the DFC290 & 490 and the dedicated fluorescence range, the DFC310FX, 340FX and the 360FX.

## Digital cameras for any application

Leica digital cameras feature standard FireWire ports for fast image transfers to PCs and Macintosh computers. The range covers everything from color cameras for a variety of applications to monochrome cameras with cooling systems for high-resolution fluorescence imaging. All digital cameras feature variable resolution with live image mode; resolutions range from 1.3 to 12 megapixels at a color depth of up to 14 bits per color channel.

\* Available for the Leica DMI6000 B only.

## Integration

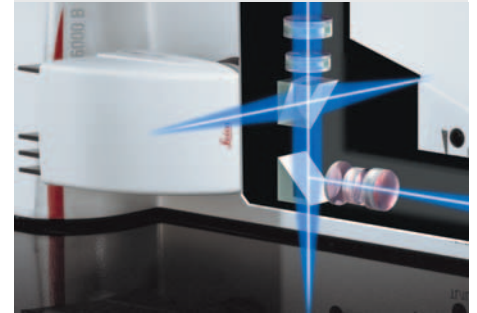

### Motorized camera ports

The side ports are controlled via a freely-configurable motorized disk. The disk can be used for beam splitters to divert 100%, 80% or 50% of the light to the left or right port. It can also accommodate a beam splitter with wavelength splitting. The bottom port is controlled by a motorized slide that diverts 100% of the arriving light to the port.

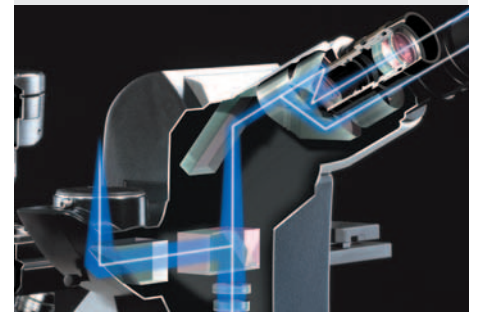

### Manual camera port

The upper camera port on the tube is manual and is available with or without a Bertrand lens. 100% or 50% of the light can be directed to the camera port as required.



Leica DFC320 digital fluorescence camera



“When observing living cells under a microscope, it’s essential to maintain optimal conditions for the organisms. Leica Microsystems offers its customers ideal accessories for any application, letting them control the environmental conditions of their cells throughout their experiments.”

**Dr. Katja Peter, Marketing Manager, Research Microscopes  
Leica Microsystems**





## From refrigerator to sauna

Stage inserts for all types of vessels, combined with temperature control units, ensure correct temperatures for your experiments. From below freezing to +60°C, any temperature is possible. Simply choose the components that best suit your requirements.

## Everything under control

A comprehensive range of control equipment is available for the Leica DMI series. Carbon dioxide control units maintain constant pH values. Oxygen controllers regulate the O<sub>2</sub> concentration required by your cells. Temperature regulators are also available to maintain any required physiological temperature.

## Perfect climate

Your specimens require defined environmental conditions for your experiments. The Leica DMI series offers everything you need in this respect. Leica climate chambers are available in a variety of sizes – from models designed to accommodate a single Petri dish, to one that encloses the entire microscope.



### Incubators

Shown is an incubator, designed for use with Petri dishes and glass slides. The transparent incubator housing is placed on a heating insert or heating stage. Glass inserts are integrated in the covers to allow observation in DIC contrast.

For detailed descriptions of the various stages, heating and cooling inserts and control instruments, please refer to Leica's separate brochure, "Live on Stage". Order number: 914 352



### Heating and cooling inserts

Leica's wide range of heating and cooling inserts covers the needs of virtually any user. Inserts for Petri dishes, coverslips, multi-well dishes, and other vessels can be integrated in the stage of your Leica DMI microscope. An M24 multi-well dish heating insert is shown.



### Controllers

The CTI Controller 3700 is used to control temperatures and carbon dioxide.

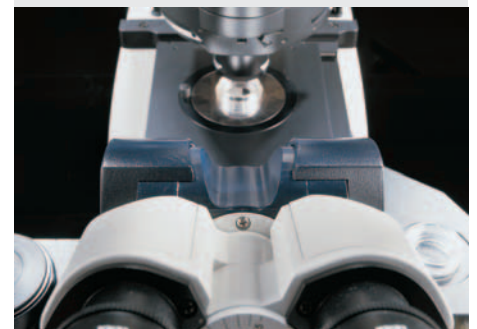

### Unobstructed view of the specimen

The "viewing channel" integrated in the tube provides a clear view of your specimen, and lets you switch from microscopic to visual observation of your specimens at any time without changing the tube setting.



# Micromanipulation

Micromanipulation places high demands on microscope systems. The integrated solution shown below consists of a Leica DMI4000 B equipped with a Leica DFC360 FX digital fluorescence camera, archiving software, and accessories for monitoring optimal experimental conditions.

## Leica DMI4000 B:

- The Contrast Manager provides fast, low-vibration changes between a variety of contrast methods.
- The automated fluorescence axis supports full remote control.
- The micromanipulation stage with its slim design allows easy adaptation of manipulators.
- The heating insert ensures optimal experimental conditions for the cells.

## Leica DFC360 FX

- The digital camera features a FireWire port for fast image transfers.

## Leica Application Suite

- It comes complete with drivers for cameras and microscopes, allowing remote control of the entire systems.

## Leica Micromanipulator

- The mechanical manipulator transmits power directly and without delays.



**Like an extra hand**

Cell manipulation belongs to the standard repertoire of biomedical researchers – be it transgenic manipulation or to inject proteins, dyes, or drug compound.

For tasks such as these, the mechanical Leica micromanipulator is unparalleled in its precision and quality, and it has been optimally adapted to the Leica DMI series. Suitable adapters for electrical and hydraulic manipulators are available for customers preferring such instruments.



The Leica AM6000\* is a system solution for the most demanding micromanipulation applications. Developed in close cooperation with Eppendorf, the result is component interaction at the very highest level. The electrical Eppendorf manipulators and the Leica DMI6000 B are optimally attuned to one another to make your work easier.

\* For more information, please request our detailed Leica AM6000 brochure.

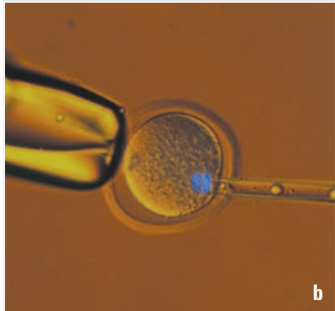
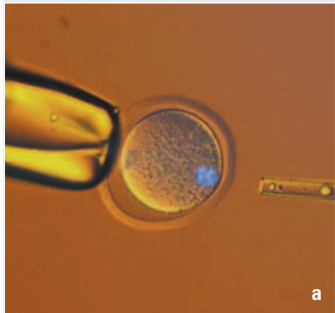

Mouse egg chromosome removal sequence (UV and transmitted light): **a** prior to removal; **b** entry of removal pipette; **c** removal; **d** verification of removal  
Image source: IGBMC, Strasbourg (F)

		<b>Leica DMI4000 B</b>	<b>Leica DMI6000 B</b>
<b>Stand</b>	<b>Power supply</b>	• in CTR4000 electronics box* <sup>1</sup>	• in CTR6000 electronics box* <sup>2</sup>
	<b>Display</b>	• information display 77 x 49 cm (W/H)	
	<b>Interfaces</b>	• RS232 • 2 x USB	
<b>Focus</b>	<b>General</b>	• manual • coarse and fine drive	• motorized • 5 electronic speeds • switching between coarse and fine mode
<b>Objective turret</b>		• 6x M25 • manual, absolute coded	• motorized, absolute coded
<b>Controls</b>	<b>Stand</b>	• 7 freely programmable buttons • buttons with fixed functions for – illumination manager, focus functions, camera ports, subsequent magnification, fluorescence functions	
	<b>SmartMove (remote control)</b>		• buttons with fixed functions for – focus threshold values, quick focus • control element for focus (z) and stage movement (x, y) • 4 freely programmable buttons
<b>Stages</b>	<b>Mechanical stages</b>	• fixed stages – various sizes – ceramic-coated – over 20 different inserts available – can be equipped with heating and cooling inserts • 3-plate cross-stages, manual (also slim form for micromanipulator)	
	<b>Motorized stages</b>	• 3-plate cross-stages, motorized (also slim form for micromanipulator) • spindle stage	
<b>Transmitted-light axes</b>	<b>Illumination arm</b>	• 12 V/100 W halogen lamp • field diaphragm (motorized or mechanical) • filter magazine for 2 filters /motorized or mechanical) • shutter (motorized or mechanical)	
<b>Condensers</b>	<b>General</b>	• condenser disk for optical elements with – 4 large openings for prisms, DF stop, BF, PH rings, IMC modulators – 3 small openings for BF, PH rings, IMC modulators • suitable for magnifications from 1.25x to 100x • integrated aperture diaphragm (motorized or mechanical) • separate polarizer (motorized or mechanical)	
	<b>S1–28</b>	• condenser disk (motorized or coded) • flip-top condenser head (motorized or mechanical)	
	<b>S70</b>	• condenser disk (motorized or coded) • fixed condenser head • mechanical lens for low magnifications	
<b>Fluorescence axis</b>	<b>Filter disk</b>	• motorized • for up to 6 filter cubes	
	<b>Illumination</b>	• 100 W Hg lamp	
<b>Automation</b>	<b>Focus</b>		• including parfocality function • positioning memory slots for fast travel to 2 z-positions
	<b>Illumination Manager, transmitted light</b>	• adjustment of brightness, aperture and field diaphragms to the objective and contrast technique currently in use	
	<b>Contrast Manager</b>	• adaptation of optical elements such as prisms or light rings to the objective and contrast technique currently in use	
	<b>Illumination Manager, fluorescence</b>	• FIM (Fluorescence Intensity Manager) – adaptation of brightness in 5 fixed levels • adjustment of field diaphragm to the eyepieces or camera chips (round or rectangular diaphragms) • IFW (Integrated Fast Filter Wheel) – very fast switching of excitation with changeover times of less than 0.05 seconds • Leica Excitation Manager – red-green attenuation in 8 levels	

\*<sup>1</sup> CTR6000 or CTR6500 boxes are used in conjunction with motorized and scanning stages.

\*<sup>2</sup> The CTR6500 box is used with scanning stages.



# System Overview

## Leica DMI3000 B, DMI4000 B and DMI6000 B

### TV systems

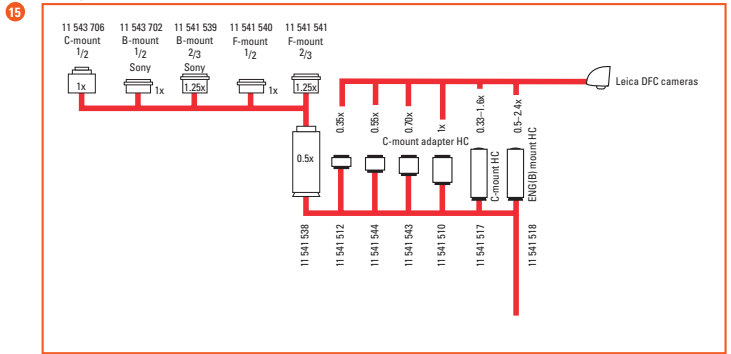

### Condensers

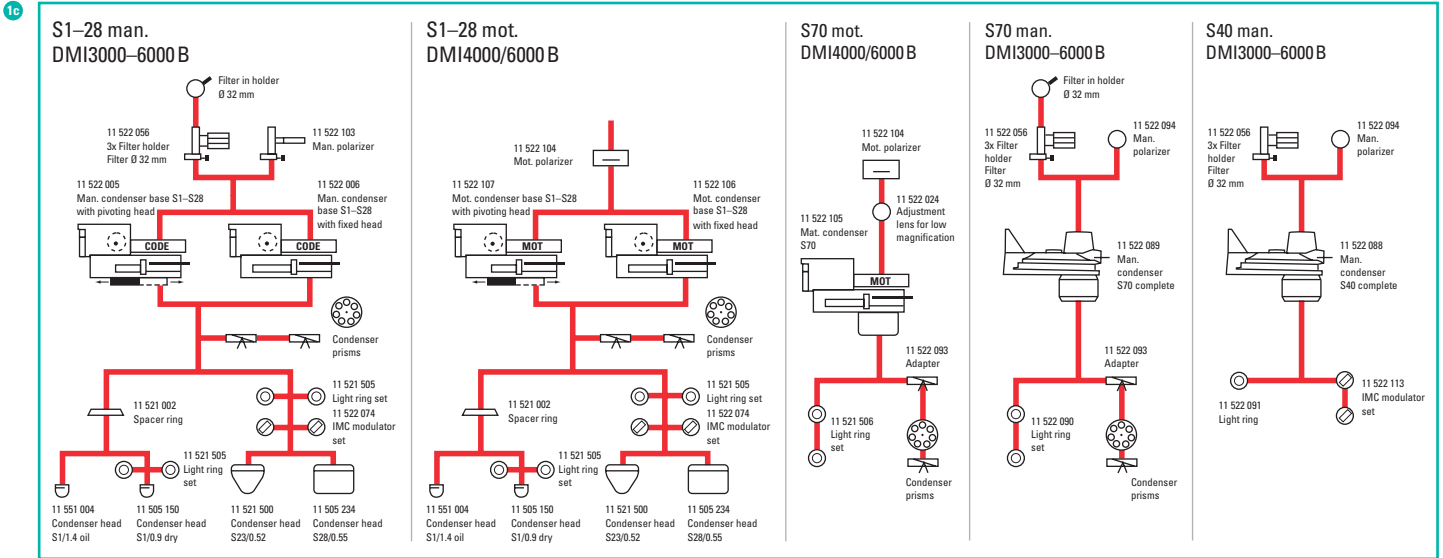

### Bino FixTube

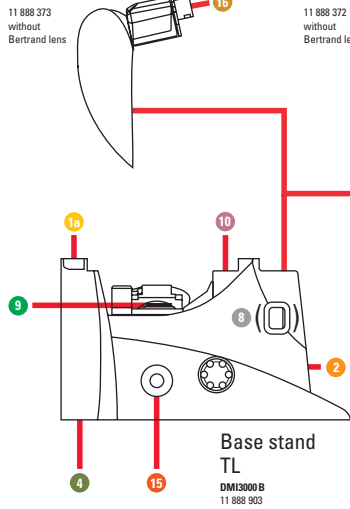

### Bino ErgoTubes

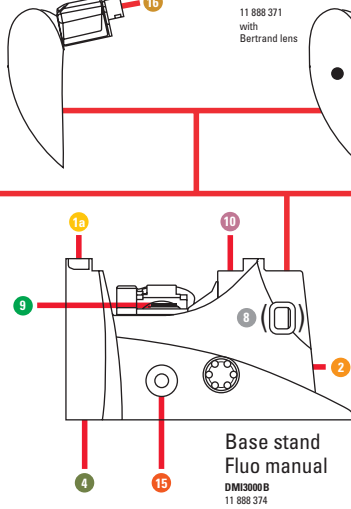

### Trino ErgoTubes

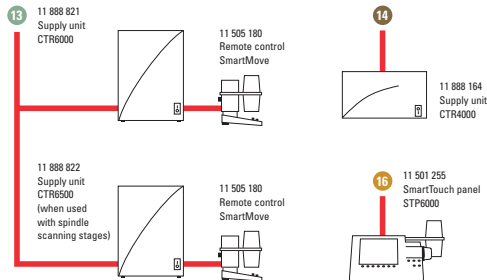
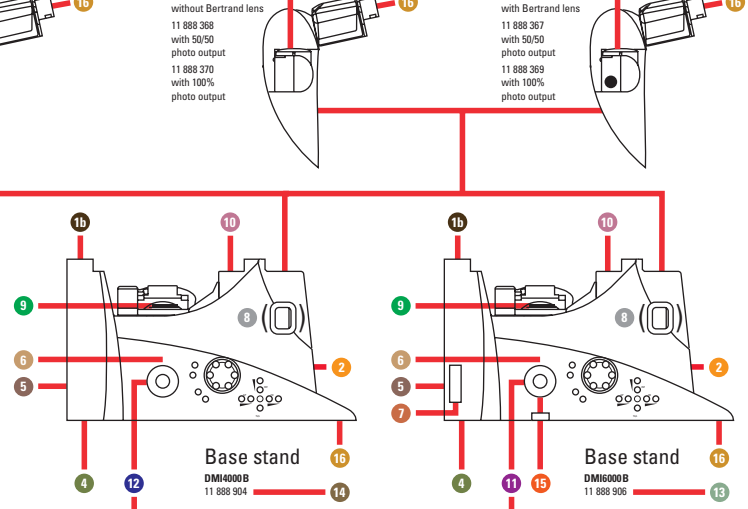

### Side ports DMI6000 B

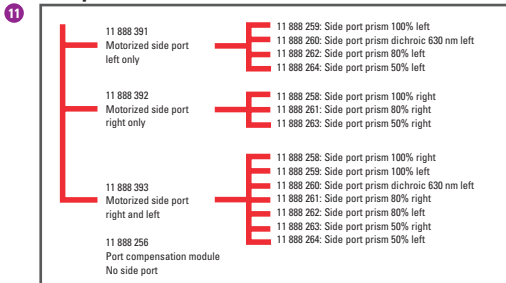

### Side ports DMI4000 B

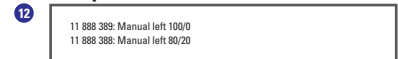

### Optic carrier

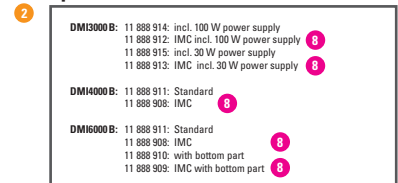

### Transmitted-light axes DMI3000 B

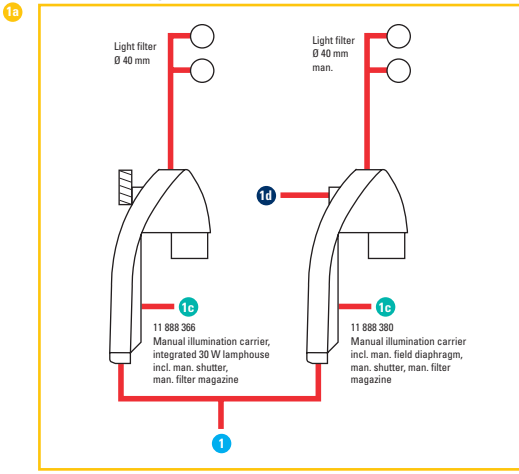

### Fluorescence lamp housings

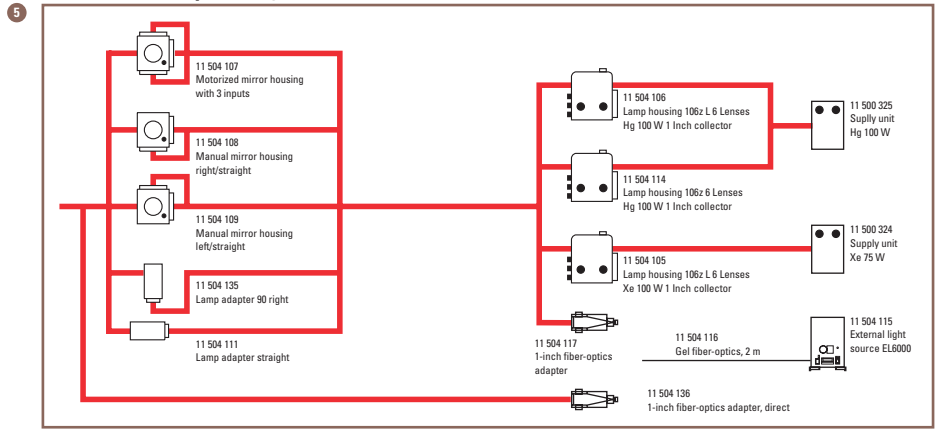

### Transmitted-light axes DMI4000/6000 B

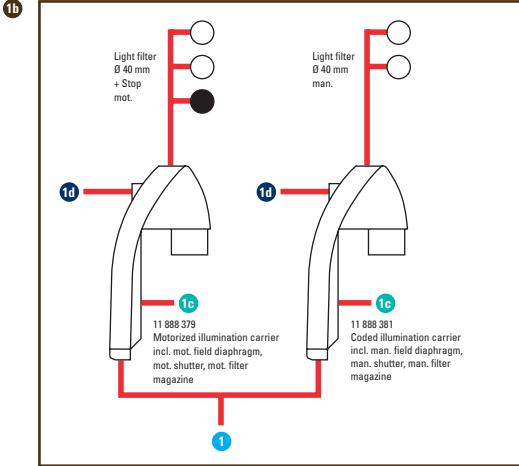

### Fluorescence axes and magnification changer

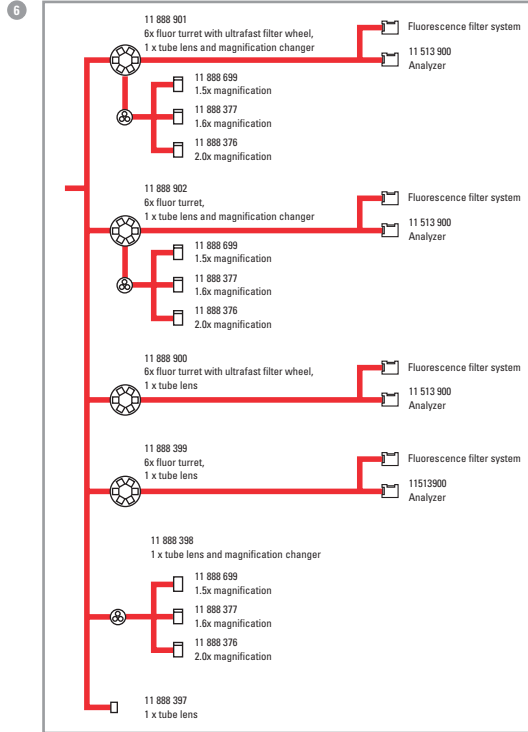

### Booster optics



### Transmitted-light lamp housings

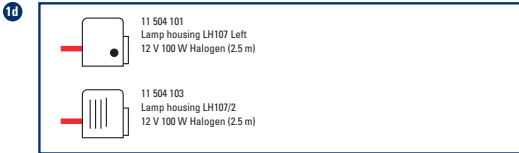

### IMC-/IPH-Systems

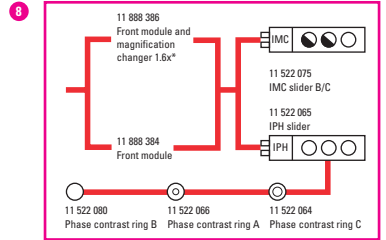

### DIC systems

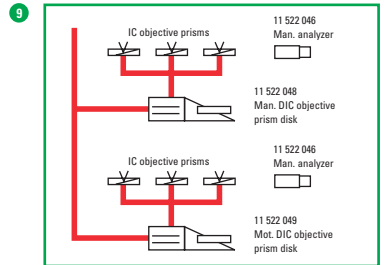

### Base plate

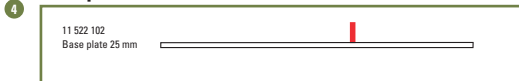

### Eyepieces

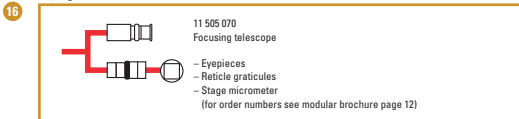

### Stages

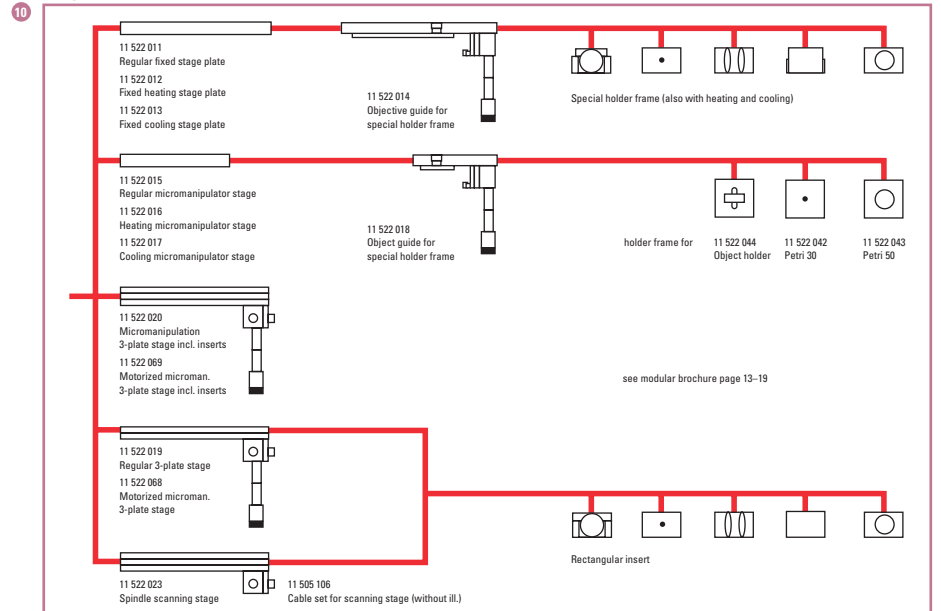

# Specifications

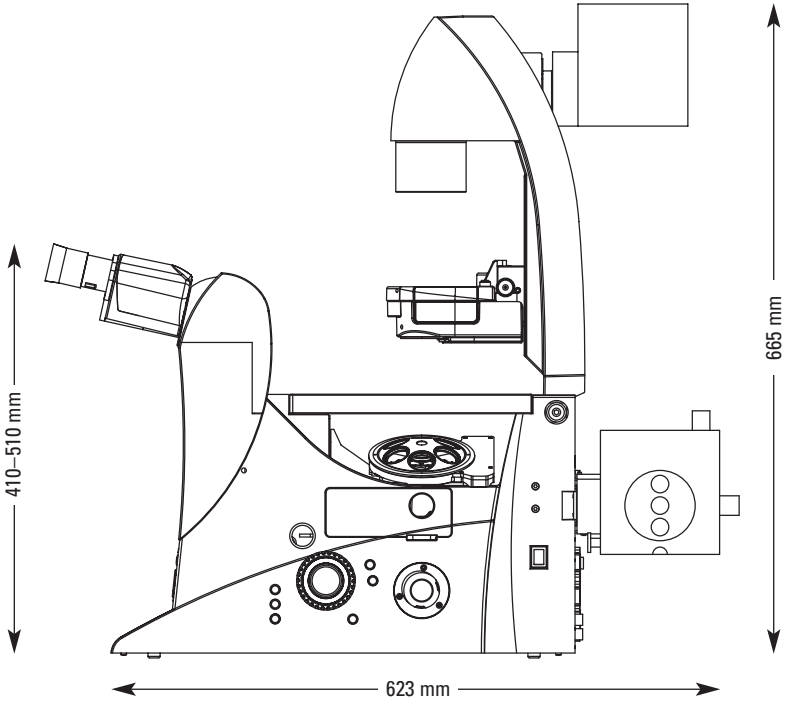
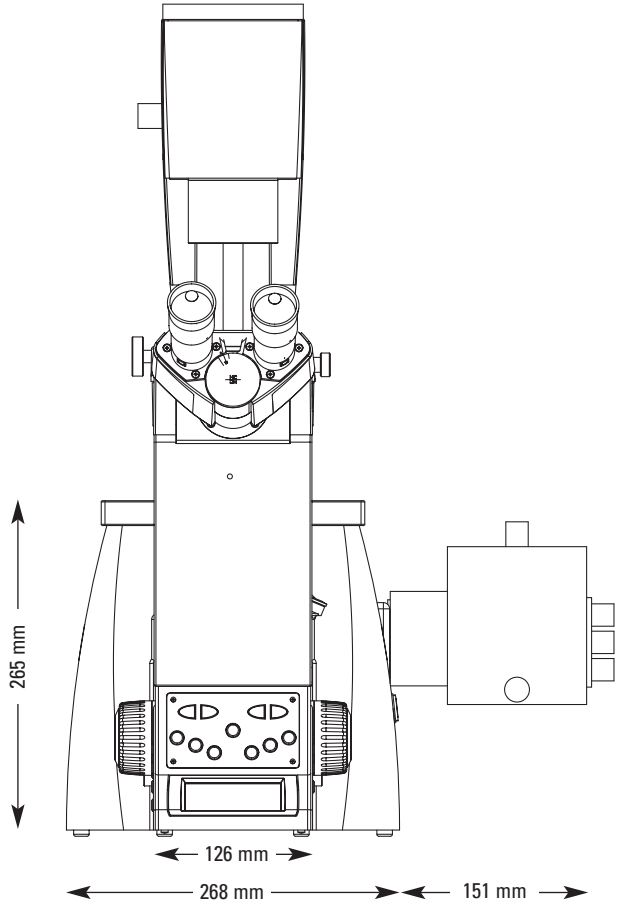
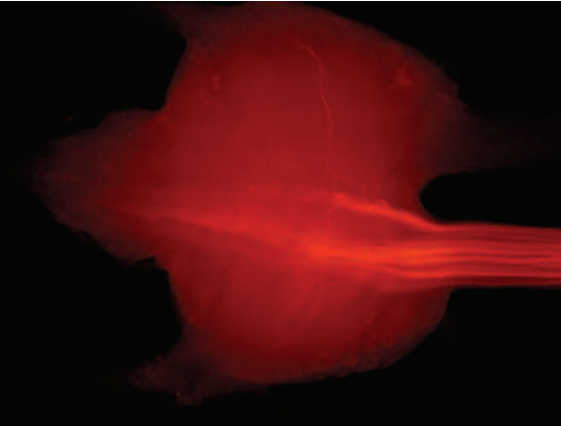
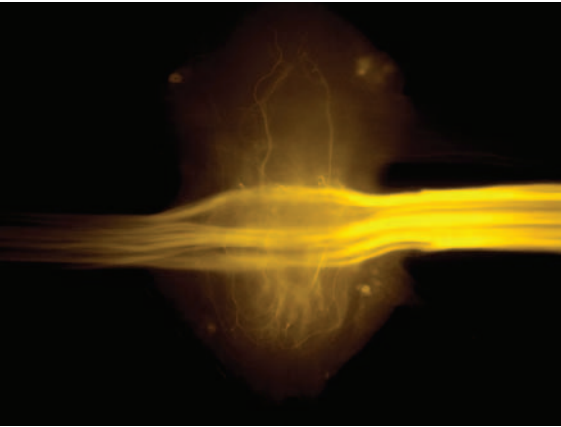
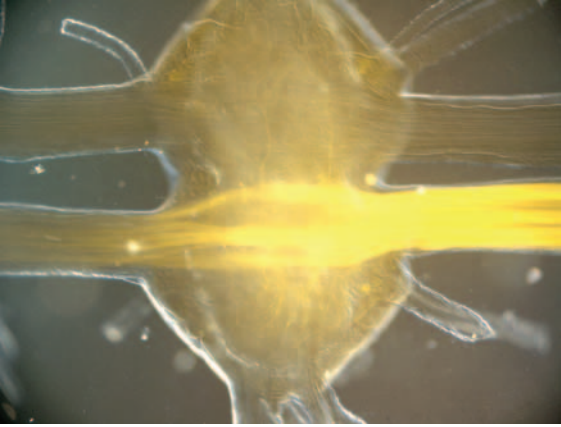



# “With the user, for the user”

## Leica Microsystems

Leica Microsystems operates globally in four divisions, where we rank with the market leaders.

### ● Life Science Division

The Leica Microsystems Life Science Division supports the imaging needs of the scientific community with advanced innovation and technical expertise for the visualization, measurement, and analysis of microstructures. Our strong focus on understanding scientific applications puts Leica Microsystems' customers at the leading edge of science.

### ● Industry Division

The Leica Microsystems Industry Division's focus is to support customers' pursuit of the highest quality end result. Leica Microsystems provide the best and most innovative imaging systems to see, measure, and analyze the microstructures in routine and research industrial applications, materials science, quality control, forensic science investigation, and educational applications.

### ● Biosystems Division

The Leica Microsystems Biosystems Division brings histopathology labs and researchers the highest-quality, most comprehensive product range. From patient to pathologist, the range includes the ideal product for each histology step and high-productivity workflow solutions for the entire lab. With complete histology systems featuring innovative automation and Novocastra™ reagents, Leica Microsystems creates better patient care through rapid turnaround, diagnostic confidence, and close customer collaboration.

### ● Medical Division

The Leica Microsystems Medical Division's focus is to partner with and support surgeons and their care of patients with the highest-quality, most innovative surgical microscope technology today and into the future.

The statement by Ernst Leitz in 1907, “with the user, for the user,” describes the fruitful collaboration with end users and driving force of innovation at Leica Microsystems. We have developed five brand values to live up to this tradition: Pioneering, High-end Quality, Team Spirit, Dedication to Science, and Continuous Improvement. For us, living up to these values means: **Living up to Life.**

### Active worldwide

Australia:	North Ryde	Tel. +61 2 8870 3500	Fax +61 2 9878 1055
Austria:	Vienna	Tel. +43 1 486 80 50 0	Fax +43 1 486 80 50 30
Belgium:	Groot Bijgaarden	Tel. +32 2 790 98 50	Fax +32 2 790 98 68
Canada:	Richmond Hill/Ontario	Tel. +1 905 762 2000	Fax +1 905 762 8937
Denmark:	Ballerup	Tel. +45 4454 0101	Fax +45 4454 0111
France:	Nanterre Cedex	Tel. +33 811 000 664	Fax +33 1 56 05 23 23
Germany:	Wetzlar	Tel. +49 64 41 29 40 00	Fax +49 64 41 29 41 55
Italy:	Milan	Tel. +39 02 574 861	Fax +39 02 574 03392
Japan:	Tokyo	Tel. +81 3 5421 2800	Fax +81 3 5421 2896
Korea:	Seoul	Tel. +82 2 514 65 43	Fax +82 2 514 65 48
Netherlands:	Rijswijk	Tel. +31 70 4132 100	Fax +31 70 4132 109
People's Rep. of China:	Hong Kong	Tel. +852 2564 6699	Fax +852 2564 4163
Portugal:	Lisbon	Tel. +351 21 388 9112	Fax +351 21 385 4668
Singapore		Tel. +65 6779 7823	Fax +65 6773 0628
Spain:	Barcelona	Tel. +34 93 494 95 30	Fax +34 93 494 95 32
Sweden:	Kista	Tel. +46 8 625 45 45	Fax +46 8 625 45 10
Switzerland:	Heerbrugg	Tel. +41 71 726 34 34	Fax +41 71 726 34 44
United Kingdom:	Milton Keynes	Tel. +44 1908 246 246	Fax +44 1908 609 992
USA:	Bannockburn/Illinois	Tel. +1 847 405 0123	Fax +1 847 405 0164

and representatives in more than 100 countries