



Leica DM500

Leica DM750

The New Generations Choice of Innovative Educational Microscopes

Living up to Life

Leica
MICROSYSTEMS

Made for Future Nobel Prize Winners

Science Teaching Revitalized

The more time the instructor has to teach, the more students can learn. The Leica DM500 and DM750 microscopes were specifically developed to revitalize science teaching and to achieve the goal of more hands-on time for Life science courses. With many student-friendly features and high-quality construction, the Leica DM500 and DM750 invigorate science learning and teach the next generation of scientists effectively and efficiently.

Superb Optics

- Based on the same optical platform as Leica Microsystems' research microscope line, students enjoy outstanding optical performance with full access to virtually all accessories from the Leica Microsystems microscope product line.
- NEW! 100x dry (no oil needed) objective provides very high resolution (N.A. 0.8) while eliminating the oil.

EZStore™

- Integrated vertical handle provides easy carrying and easy lifting when storing on high shelves; undercut on front of stand works in combination with the handle for safer, two-handed carrying.
- Integrated cord wrap eliminates damage to microscope components from improper cord wrapping; vertical cord insertion prevents the cord from pulling partially out of the stand while in storage or in use.
- The unique shape of the microscope stand protects controls from damage when microscopes are stored side-by-side.

EZGuide™

- Student friendly slide holder to prevent slide chipping.

EZLite™

- LED illumination provides cool, white light with a lifetime of over 20 years average use. No longer need to change lamps during lab time and save the expense of replacement lamps.
- The cost-savings pays for several microscopes over their lifetimes.

SafeTStage™

- Microscope stage maintains its dimension, which eliminates the chance of injury from contact with a conventional stage rack.
- Rounded edges are easy on the skin.

AgTreat™

- The spread of disease from surfaces is of great concern, especially in educational environments. Leica Microsystems has integrated an additive so that all microscope touchpoints are treated to inhibit the growth of bacteria. This helps to prevent the spread of disease via the microscope surfaces and leads to a healthier laboratory environment.



DM500 – Science Teaching Made Easy

The Leica DM500 is ideal for first level Life Science courses. The microscope's stand features provide "plug and play" capability. All students need to do is turn the power on, place the specimen slide on the stage, focus, and enjoy the view!



Ready to work

- Pre-centered, pre-focused condenser eliminates the need for adjustments



EZTube™

- Eyepieces integrated with the eyetubes to prevent loss
- Preset diopter adjustments eliminating the opportunity to incorrectly set diopters
- Other viewing tubes are also available



Safe Rotation

- Patented captive thumb-screw for safe rotation of the EZTube™



All in one

- Condenser slot for phase contrast and darkfield sliders, including patented 4 position phase slider which offers brightfield and phase capabilities all in one slider



Perfect light

- LED illumination designed to provide even lighting across the full field of view without adjustments
- Also available with a rechargeable battery powered stand for field use

DM750 – Science Teaching for a New Generation

The Leica DM750 is designed specifically for the versatile needs of advanced Life Science courses as well as for professional training such as medical, veterinary, and dental schools.

Versatile possibilities

- Standard condenser for magnifications 4x – 100x
- Phase turret condenser for brightfield and phase contrast
- Flip top condenser for low magnifications
- The DM750 is available with a 4 position or 5 position nosepiece



Wear resistant

- Special stage finish offers additional protection from friction damage



Energy saving

- Patented time delay shutoff saves energy by automatically turning off the illumination after 2 hours of no use



A+ focus, contrast & illumination

- Weighted focus knobs provide inertia and extremely accurate focus capability
- Koehler field diaphragm available as an option for optimum illumination and contrast



Shared viewing made easy

- Variety of viewing tubes provide free rotation while securely fixed to the stand
- Standard viewing tubes with eyepiece locking screws to prevent loss of eyepieces



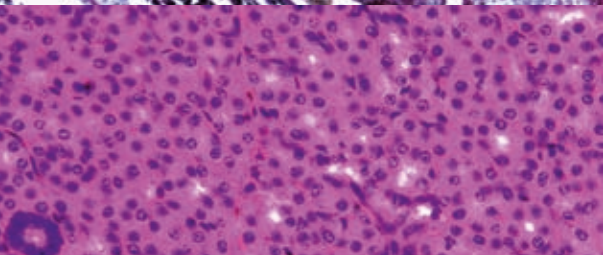
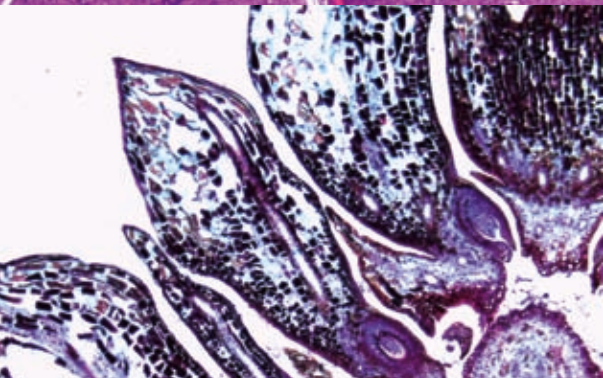
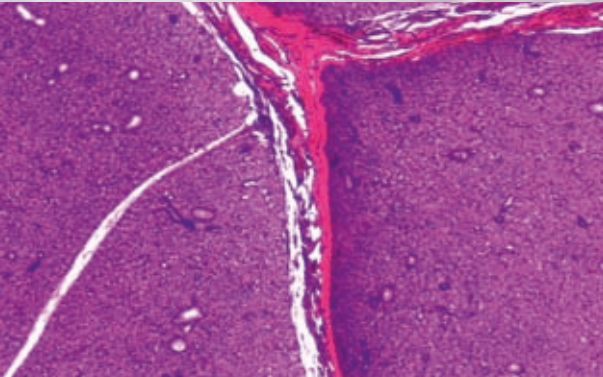
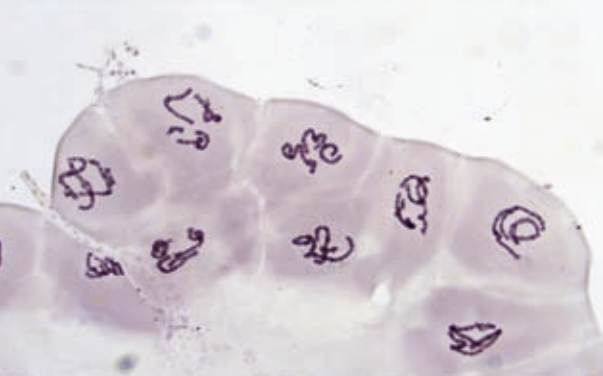
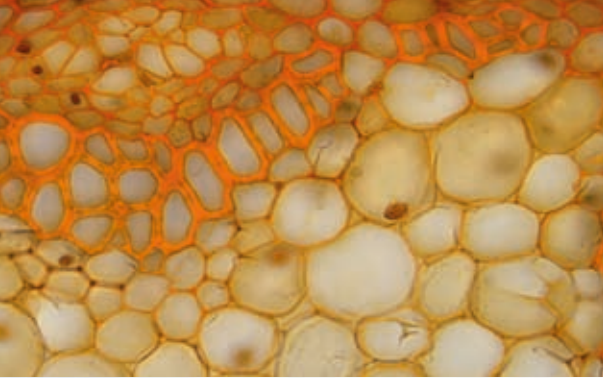
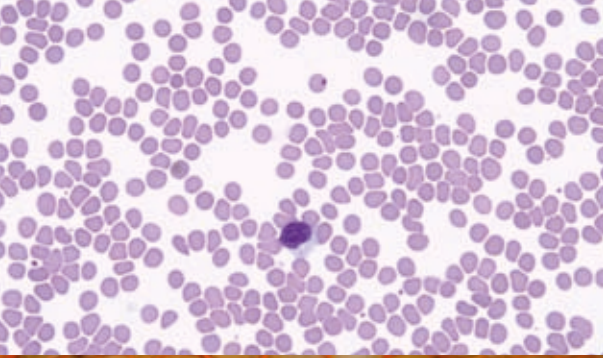

The ability to share, capture, and archive images is an important part of the microscopy laboratory. Now available: the full range of Leica Microsystems imaging solutions, including the one-of-a-kind Leica ICC50 digital camera module.

Leica ICC50 Camera Module – Integrated and Modular

- Integrated: Fits between the microscope's viewing tube and stand for the best system integration and alignment.
- Modular: A stand-alone kit enables the user to capture images directly onto an SD memory card or to use the analog output for direct connection to a data projector.
- The camera's 3-megapixel CMOS sensor provides high-resolution and fast live images .
- The USB output directly connects the Leica ICC50 camera to a computer and also provides power to the camera, which eliminates the need for an additional power supply.
- Includes Leica Application Suite (LAS) EZ software for easy camera control, image capture, annotation, measurement and documentation.
- Compatible with a wide selection of optional Leica Microsystems software modules.
- The modular design of the system allows easy upgrades and service.

A variety of trinocular viewing tubes and C-mount adapters provide the versatility to use stand-alone cameras; including the economical Leica EC3 digital camera, which opens the door to unlimited imaging possibilities

A New Approach to Imaging



System diagram Leica DM500 / DM750

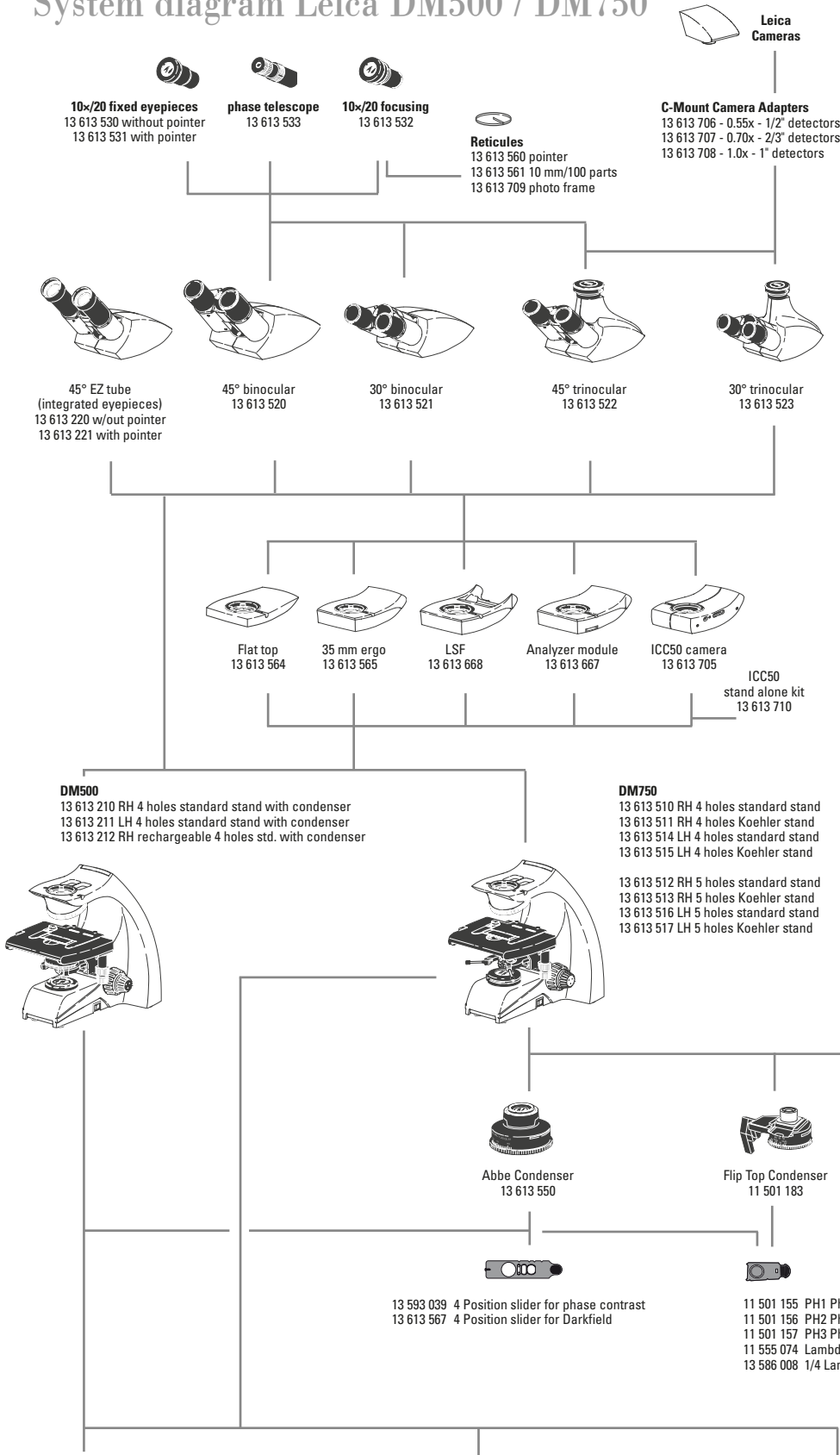

Replacements

- 13 613 563 Eyeguard pair
- 13 RFAG30002 Fuses for DM500, DM750
- 13 613 571 Thumbscrew pair for DM750 condenser mount
- 13 613 572 Set screw pair for DM750 condenser mount
- 13 613 584 Dust cover DM500, DM750
- 13 613 210-100 DM500 User documents
- 13 613 510-100 DM750 User documents
- 13 613 705-100 ICC50 User documents
- 13 613 573 Add on lens for condensers with DM750 (included with stand)
- 11 505 249 Rechargeable battery set

Analyzer Module Sliders

- 11 555 045 Fixed analyzer slider
- 11 555 079 180° Rotatable analyzer slider
- 11 555 080 360° Rotatable analyzer slider

Others

- 13 613 262 Captive thumbscrew for EZ tube
- 13 613 261 Rubber grips for X/Y controls
- 13 613 568 DF1 Ring for High Dry Darkfield with 13613551 Turret Condenser
- 13 614 800 Immersion oil
- 11 513 106 Stage micrometer
- 11 505 091 Diffuser slider for using 2.5x objective with Abbe condenser
- 11 505 507 Auxilliary lens for using 2.5x objective with 11501183 flip top condenser
- 13 613 566 32 mm filter holder
- 13 596 016 Hard carrying case
- 10 450 245 Soft carrying case
- 13 613 562 Simple pol kit
- 11 505 250 Solar panel

International Power Cords

- 13 613 900 U.S.
- 13 613 901 Europe Continental
- 13 613 902 U.K.
- 13 613 903 Switzerland
- 13 613 904 Denmark
- 13 613 905 Italy
- 13 613 906 Australia
- 13 613 907 China
- 13 613 908 Japan
- 13 613 909 Israel
- 13 613 910 South Africa
- 13 613 911 India
- 13 613 912 Argentina

Plan FOV 18 objectives

- 13 613 240 - Plan 4x/0.10 NA, 26.2 mm *
 - 13 613 241 - Plan 10x/0.22 NA, 7.8 mm *
 - 13 613 242 - Plan 40x/0.65 NA, 0.31 mm *
 - 13 613 243 - Plan 100x/1.25 NA, 0.10 mm *, Oil
- * working distance

HI Plan FOV 20 objectives

- 11 506 226 - HI Plan 4x/0.10 NA, 18.0 mm *
 - 11 506 228 - HI Plan 10x/0.25 NA, 12.0 mm *
 - 11 506 276 - HI Plan 20x/0.40 NA, 0.92 mm *
 - 11 506 236 - HI Plan 40x/0.65 NA, 0.36 mm *
 - 11 506 237 - HI Plan 63x/0.75 NA, 0.31 mm *
 - 11 506 238 - HI Plan 100x/1.25 NA, 0.10 mm *, Oil
 - 11 506 322 - HI Plan 100x/0.80 NA, 0.3 mm* dry objective
- * working distance

HI Plan Phase FOV 20 objectives

- 11 506 230 - HI Plan Phase 10x/0.25 NA, 12.0 mm *
 - 11 506 278 - HI Plan Phase 20x/0.40 NA, 0.92 mm *
 - 11 506 240 - HI Plan Phase 40x/0.65 NA, 0.36 mm *
 - 11 506 241 - HI Plan Phase 100x/1.25 NA, 0.10 mm * Oil
- * working distance

Preconfigured Outfits Leica DM500 / DM750

OUTFIT ORDERING NUMBER		13613200	13613201	13613500	13613503	13613501	13613504	13613502	13613505
		DM500	DM500	DM750	DM750	DM750	DM750	DM750	DM750
STANDS									
13613210	DM500 RH Stand with Condenser	X	X						
13613510	DM750 RH Stand			X	X	X	X		
13613511	DM750 RH Stand Koehler							X	X
TUBES									
13613220	45° EZ Tube	X		X					
13613221	45° EZ Tube with pointer		X		X				
13613520	45° Binocular Tube					X	X	X	X
EYEPIECES									
13613530	10x/20 Eyepiece with eyeguard					X		X	
13613531	10x/20 Pointer eyepiece w/eyeguard						X		X
13613532	10x/20 Focusing eyepiece w/eyeguard					X	X	X	X
CONDENSERS									
13613550	Abbe Condenser 0.9Dry/1.25 Oil			X	X	X	X	X	X
OBJECTIVES									
13613240	Plan 4x/0.10NA, 26.2 mm W.D.	X	X	X	X				
13613241	Plan 10x/0.22 NA, 7.8 mm W.D.	X	X	X	X				
13613242	Plan 40x/0.65 NA, 0.31 mm W.D.	X	X	X	X				
13613243	Plan 100x/1.25 NA, 0.10 mm W.D., Oil	X	X	X	X				
11506226	HI Plan 4x/0.10NA, 18.0 mm W.D.					X	X	X	X
11506228	HI Plan 10x/0.25 NA, 12.0 mm W.D.					X	X	X	X
11506236	HI Plan 40x/0.65 NA, 0.36 mm W.D.					X	X	X	X
11506238	HI Plan 100x/1.25 NA, 0.10 mm W.D., Oil					X	X	X	X
13614800	Immersion Oil	X	X	X	X	X	X	X	X
POWER CORD NOT INCLUDED: Must be ordered separately									

Dimensions Leica DM500 / DM750

Dimensions in mm/inch

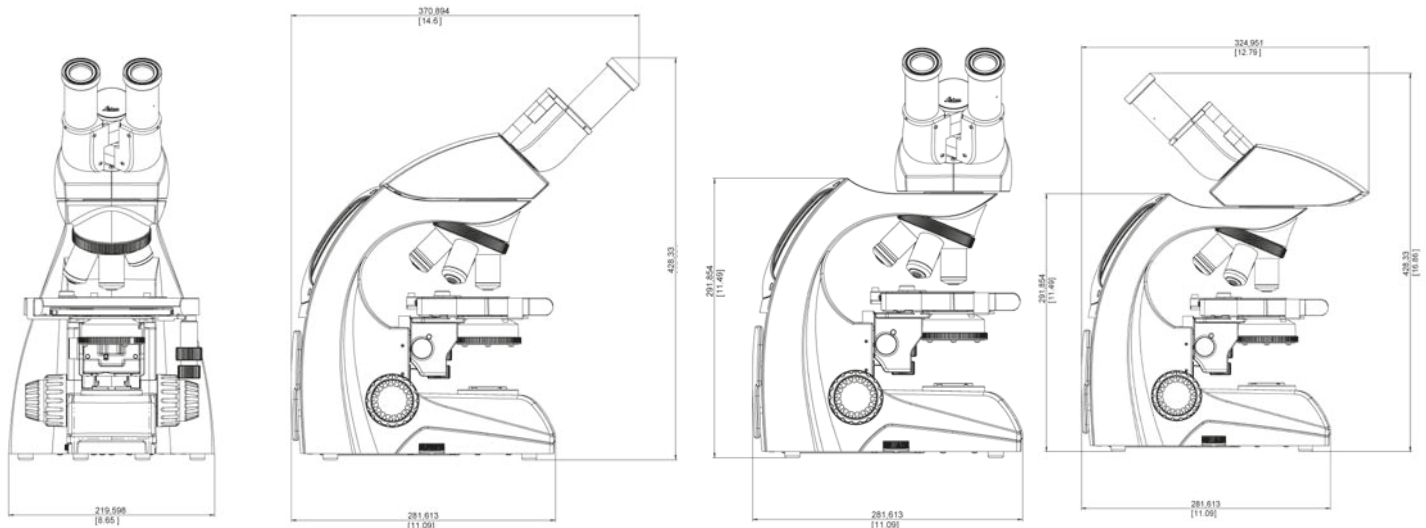

Leica DM500 / Leica DM750 – Specifications

	DM500	DM750
SEPARATE EYEPIECES		
High eyepoint	X	X
10x/20 (20 mm field of view)	X	X
Available with or without pointer	X	X
Available fixed or focusing	X	X
Focusing eyepieces with reticule holder for 21mm reticle	X	X
Foldable eyeguards	X	X
30 mm mounting diameter	X	X
EZTube™		
Preset diopters for corrected vision	X	X
45 degree viewing angle	X	X
10x/18 (18 mm field of view)	X	X
Attaches to stand with set screw	X	X
Captive thumbscrew available for safe rotation	X	X
Eyepieces are integrated into tube	X	X
Available with pointer and without pointer	X	X
Interpupillary distance range 52 mm – 75 mm	X	X
Other Viewing Tubes for separate eyepieces		
45 degree, 30 degree, trinocular	X	X
Maximum field of view 20 mm	X	X
Rotatable dovetail	X	X
Leica tube dovetail standard	X	X
Eyepiece locking screw	X	X
Interpupillary distance range 52 mm – 75 mm	X	X
Stand		
Stand shape protects controls	X	X
Stand construction - die-cast aluminium	X	X
External fuses	X	X
Knurled nosepiece	X	X
4 position nosepiece only	X	
4 or 5 position nosepiece available		X
Drop in holder for 32 mm mounted or not mounted filters	X	X
EZStore™		
Vertical handle	X	X
Undercut in front of stand	X	X
Cord wrap	X	X
Vertical cord attachment to stand	X	X
Objectives		
Infinity platform	X	X
Plan optics for FOV 18	X	X
HI Plan for FOV 20	X	X
100x dry objective with N.A. 0.8 (no correction collar)	X	X
Objective labeling laser engraved (HI Plans)	X	X
M25 nosepiece thread	X	X
EZGuide™		
One-handed slide loading	X	X
26 mm x 76 mm stage travel	X	X

	DM500	DM750
SafeTStage™		
Stage surface 185 mm (150 mm front) wide x 140 mm deep	X	X
Rounded stage edges	X	X
Non extending rack	X	X
Verniers for X/Y coordinates	X	X
Wear resistant stage surface		X
Condenser		
Prefocused and precentered condenser	X	
Centerable and focusable condenser mount		X
Slot in condenser for contrast sliders (phase, darkfield, compensator)	X	X
Magnification labels on condenser	X	X
Standard Leica condenser mount for condensers (Abbe, turret, flip top, etc.)		X
Focus		
Low position focus controls	X	X
Self adjusting focus mechanism	X	X
300 microns per fine focus rotation	X	X
Calibrated in 3 micron increments	X	X
Weighted focus knobs		X
EZLite™		
Preset field aperture only	X	
Available with or without adjustable Koehler field diaphragm		X
LED illumination - 6000 K temp, 25,000 h life at full intensity	X	X
Continuous intensity adjustment	X	X
Illumination enough for viewing at lowest intensity	X	X
Simple polarizing kit available	X	X
2 hour Auto Off (can be disabled or enabled)		X
Auto Off default: 4 hole stands enabled, 5 hole stands disabled		X
Imaging		
Trinocular tubes available (50%/50% light split)	X	X
C mount adapters with standard Leica mount	X	X
ICC50 intermediate camera module (50%/50% light split)	X	X
Stand alone kit for ICC50 camera module (Power supply, analog video cable)	X	X
Intermediate Modules		
35 mm intermediate ergo module available	X	X
15 mm flat top module	X	X
Module for LSF reflected light illuminator	X	X
Analyzer module with pin for viewing tube alignment	X	X
AgTreat™		
Anti microbial treatment	X	X
Certifications		
cULus, CE, RoHS		
Shipping		
Dimensions: 40 cm x 37 cm x 39 cm		
Weight: 9 kg	X	X

Clean and Green

We actively implement ways to make our environment cleaner and safer for this generation and the next:

- All packaging is completely recyclable.
- No Lead content in any of the glass components.
- LED illumination consumes approximately 80% less energy than standard halogen illumination.
- The time delay shutoff feature found on the Leica DM750 ensures no energy is wasted.
- Constantly optimizing our logistics chain to keep the CO₂ footprint as low as possible.
- AgTreat™ helps to prevent the spread of disease via the microscope surfaces and leads to a healthier laboratory environment.
- All products have been tested by independent safety laboratories and carry the cULus and CE mark to indicate their design for safety.
- All products are RoHs compliant, which means all electrical components meet any restrictions on the use of hazardous substances.

See more at www.leica-microsystems.com/education

- Interactive tour of the DM500 and DM750
- E-Series of stereo microscopes for low magnification inspection, dissecting, and image capture
- Leica DM750 P Polarizing Microscope for Earth and Materials Science education
- Selection of higher level microscopes for Research
- A selection of posters and instructional booklets which are free of charge

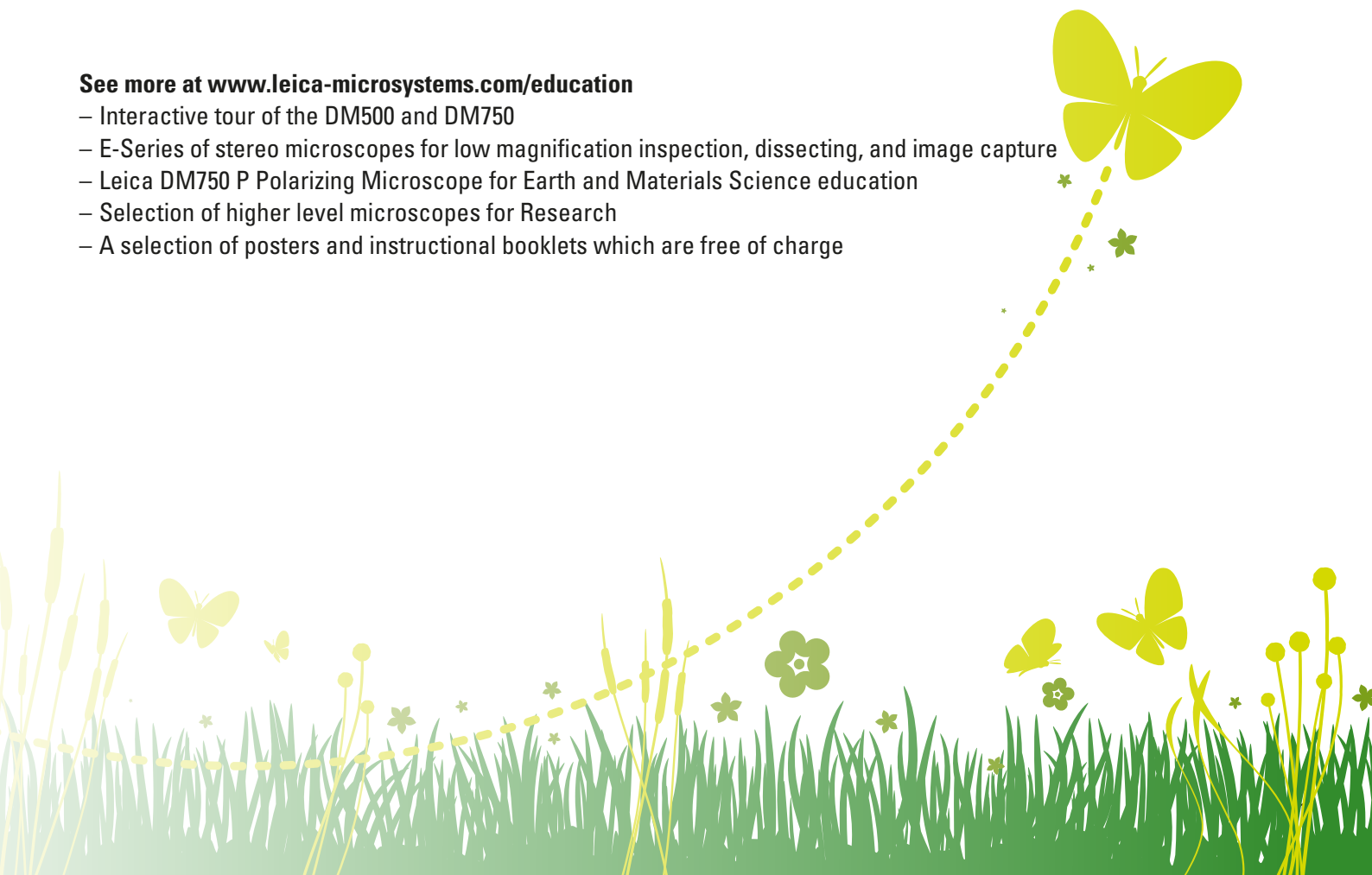

“With the user, for the user”

Leica Microsystems

Leica Microsystems operates globally in four divisions, where we rank with the market leaders.

• Life Science Division

The Leica Microsystems Life Science Division supports the imaging needs of the scientific community with advanced innovation and technical expertise for the visualization, measurement, and analysis of microstructures. Our strong focus on understanding scientific applications puts Leica Microsystems' customers at the leading edge of science.

• Industry Division

The Leica Microsystems Industry Division's focus is to support customers' pursuit of the highest quality end result. Leica Microsystems provide the best and most innovative imaging systems to see, measure, and analyze the microstructures in routine and research industrial applications, materials science, quality control, forensic science investigation, and educational applications.

• Biosystems Division

The Leica Microsystems Biosystems Division brings histopathology labs and researchers the highest-quality, most comprehensive product range. From patient to pathologist, the range includes the ideal product for each histology step and high-productivity workflow solutions for the entire lab. With complete histology systems featuring innovative automation and Novocastra™ reagents, Leica Microsystems creates better patient care through rapid turnaround, diagnostic confidence, and close customer collaboration.

• Surgical Division

The Leica Microsystems Surgical Division's focus is to partner with and support surgeons and their care of patients with the highest-quality, most innovative surgical microscope technology today and into the future.

The statement by Ernst Leitz in 1907, “with the user, for the user,” describes the fruitful collaboration with end users and driving force of innovation at Leica Microsystems. We have developed five brand values to live up to this tradition: Pioneering, High-end Quality, Team Spirit, Dedication to Science, and Continuous Improvement. For us, living up to these values means: **Living up to Life.**

Active worldwide

Australia:	North Ryde	Tel. +61 2 8870 3500	Fax +61 2 9878 1055
Austria:	Vienna	Tel. +43 1 486 80 50 0	Fax +43 1 486 80 50 30
Belgium:	Groot Bijgaarden	Tel. +32 2 790 98 50	Fax +32 2 790 98 68
Canada:	Richmond Hill/Ontario	Tel. +1 905 762 2000	Fax +1 905 762 8937
Denmark:	Herlev	Tel. +45 4454 0101	Fax +45 4454 0111
France:	Rueil-Malmaison	Tel. +33 1 47 32 85 85	Fax +33 1 47 32 85 86
Germany:	Wetzlar	Tel. +49 64 41 29 40 00	Fax +49 64 41 29 41 55
Italy:	Milan	Tel. +39 02 574 861	Fax +39 02 574 03392
Japan:	Tokyo	Tel. +81 3 5421 2800	Fax +81 3 5421 2896
Korea:	Seoul	Tel. +82 2 514 65 43	Fax +82 2 514 65 48
Netherlands:	Rijswijk	Tel. +31 70 4132 100	Fax +31 70 4132 109
People's Rep. of China:	Hong Kong	Tel. +852 2564 6699	Fax +852 2564 4163
Portugal:	Lisbon	Tel. +351 21 388 9112	Fax +351 21 385 4668
Singapore		Tel. +65 6779 7823	Fax +65 6773 0628
Spain:	Barcelona	Tel. +34 93 494 95 30	Fax +34 93 494 95 32
Sweden:	Kista	Tel. +46 8 625 45 45	Fax +46 8 625 45 10
Switzerland:	Heerbrugg	Tel. +41 71 726 34 34	Fax +41 71 726 34 44
United Kingdom:	Milton Keynes	Tel. +44 1908 246 246	Fax +44 1908 609 992
USA:	Bannockburn/Illinois	Tel. +1 847 405 0123	Fax +1 847 405 0164

and representatives in more than 100 countries

In accordance with the ISO 9001 certificate, Leica Microsystems (Switzerland) Ltd, Industry Division, has at its disposal a management system that meets the requirements of the international standard for quality management. In addition, production meets the requirements of the international standard ISO 14001 for environmental management.