

# Axio Observer

## What Would You Like to Know About Life Today?



**Observing. Manipulating. Analyzing.**  
**The Inverse Research Platform for**  
**Live Cell Imaging.**



We make it visible.

# How Do You Increase Access to the Most Demanding Life Science Applications?

The human genome was decoded in 2001, which was a scientific revolution. This prompted a flurry of questions in the scientific community. Since that time, international research teams looking into processes inside and between living cells have been concerned less with the “What” and more with the “How”. How do molecules or proteins, lipids, enzymes, DNA and RNA function? How do they interact? And why?

In their search for answers to these questions, researchers focus their efforts on the most sophisticated microscopic techniques for observation, manipulation and analysis. None more so than those involving fluorescence. The development of such techniques has become a mission for Carl Zeiss, and one that the company has assigned a name: FluoresScience. For many years, this initiative has been providing the leading microscope systems for applied and basic research, and helping researchers to open new pathways of discovery in science.

Now a technical innovation is moving science a step further: Axio Observer, the inverted research microscope from Carl Zeiss. It has been developed for maximum flexibility in the Live Cell techniques of today and tomorrow and realized as a fully integrated research platform for cell observation, cell manipulation and cell analysis. It can be expanded cost-effectively from a basic stand for tissue culture and fluorescence, to one for high speed, laser scanning microscopy or microdissection. Axio Observer: what better way is there to meet the high demands of Life Science projects today?



# Axio Observer







# Have Optics Reached Their Limits With Living Cells?

Carl Zeiss has been continuously stretching the possibilities of its research optics to their very limits. With Axio Observer we are further strengthening our technological leadership position – with new developments in contrasting methods, objectives and numerous innovative details. At the limits of visibility, these developments provide greater information content, better adjustment to versatile Live Cell applications, and even more convenient processes.

## Each series in a class of its own: the objectives

The “eyes” of the inverted Axio Observer research platform – developed to perform the different tasks in Live Cell Imaging brilliantly. Each objective series is in a class of its own:

- **LCI Objectives** LCI Plan-Neofluar 25x, 63x and LD LCI Plan-Apochromat 25x. Superb multi-immersion objectives with optimal correction options for spherical aberration, tailored to the special temperature spectrum in Life Science experiments. The LD variant makes it possible to focus even more deeply into the sample.

- **Insulated objectives** i LCI Plan-Neofluar 25x and 63x and i Plan-Apochromat 63x. Thermal insulation is the only way to ensure the perfect temperature at the specimen.
- **LD Plan-Neofluar Ph1 Ph2- Corr**, the innovation: positive and negative phase contrast combined in one objective.
- **C-Apochromat und LD C-Apochromat**, perfect for uncompromising high resolution. Ideal for LSM, ApoTome and Deconvolution.
- **Plan-Apochromat** for extremely high demands on image leveling and color correction.
- **LD Plan-Neofluar**, sophistication and versatility, useable for all cover glass specimens (0.17 mm) and plastic culture plates with a bottom thickness of up to 2 mm.
- **EC Plan-Neofluar** Neofluar for outstanding contrast and multiple image techniques.
- **LD A-Plan**, the favorable, flexible standard objectives from Carl Zeiss for inverted microscopy.

## Optimal for the entire field of view: the new DIC

The new generation of **Differential Interference Contrast** provides brilliance and homogeneous illumination across the entire field of view. Image details are resolved well with highest resolution and

DIC

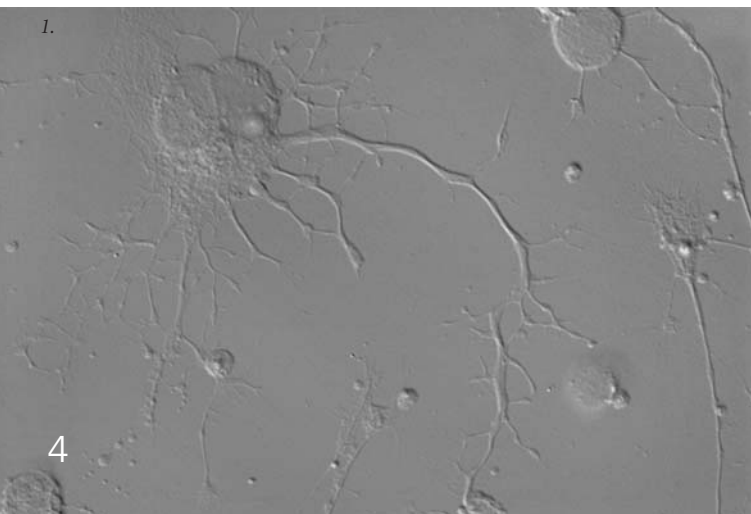

DIC

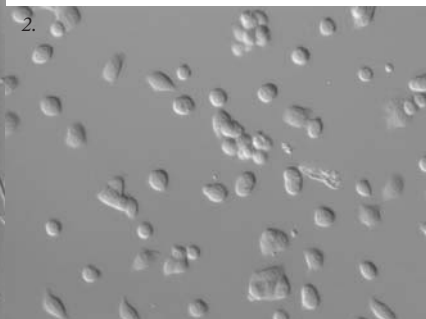

PlasDIC



1. Forebrain neurons (rat) cultured on poly-D-lysine/laminin coated glass coverslips. J. Perron, Columbia University, Columbia, USA.
2. MDCK cells (dog) after short incubation period. R. Nitschke, Life Imaging Center, University of Freiburg, Germany.



outstanding contrast across a 25 mm field of view. A further innovation is the combination of polarizer and Nomarski prism in a sandwich design. The advantage to you: there is no need to engage the polarizer manually.

**Practical, economic, impressive:  
PlasDIC**

Glass or plastic? The economic relief contrast from Carl Zeiss is insensitive to birefringent materials and is therefore just as suitable for plastic dishes as it is for glass bottom vessels. In terms of application, PlasDIC is recommended for use with thicker adherent cells or oocytes and is ideally suited to Intracytoplasmic Sperm Injection (ICSI) due to the excellent relief display. PlasDIC is easy to operate and already functions with the cost-effective LD A-Plan objectives. If your requirements grow, we recommend the LD Plan-Neofluar objectives.

**Innovation in plus and minus:  
the phase contrast**

Familiar, yet surprisingly different: the new phase contrast in an economic 2-in-1 solution and a new area of application. The negative phase contrast works well with thick cell areas or stages of division. The combination of positive and negative phase contrast now makes it possible to contrast all the structures of your object perfectly using one objective. Switching is easy, involving a simple diaphragm change. You will appreciate the new phase contrast for normal monitoring, as well as for special morphological problems.

**Automatically quicker:  
the new transmitted light shutter**

A new standard since the introduction of Axio Observer: faster switching, silent operation and low vibration. Time is saved and operation made easier thanks to a new integrated shutter concept. Automated in transmitted light for the first time, with a short switching time making it perfect for the configuration of time lapse experiments, e.g. for the rapid switch between transmitted light and fluorescence.

**Phase +**

**Phase -**

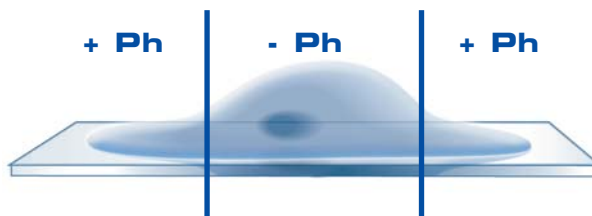
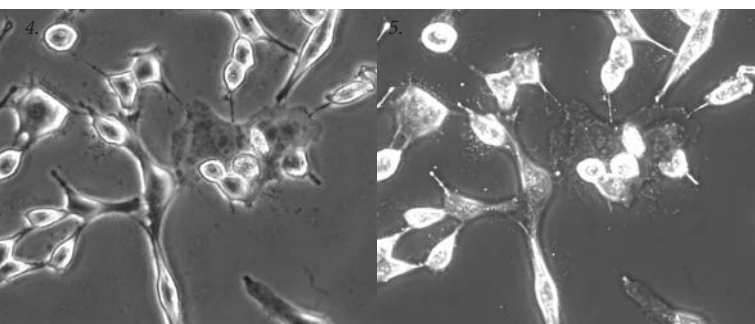

3. Human embryos (four-cell stage).  
S. Mittmann, IVF-Labor, Göttingen, Germany.

4. und 5.: MDCK cells (dog) – thick cell areas are displayed better using negative phase contrast.  
R. Nitschke, Life Imaging Center, University of Freiburg, Germany.

# Why Does Everything Revolve Around Optimum Fluorescence?

Highly differentiated fluorescence techniques – in research on living cells these are becoming the standard. Carl Zeiss is focusing its knowledge and innovation on further developing these techniques. So that they may be made accessible to new applications all the time. At the forefront of the development of inverted microscopes stands is the Axio Observer – with the most efficient, flexible and gentlest fluorescence, protecting your cells and leading to brilliant results.

## Perfected for all wavelengths: the new fluorescence beam path

Axio Observer represents a new level of quality in fluorescence. Corrected apochromatically, it offers consistently good contrasting and homogeneous illumination right into the periphery at almost any excitation wavelength. The advantage to you:

From center to edge, in multichannel fluorescence all wavelengths are equally balanced in intensity and signal to noise. There is also the alternative option of the beam path with an extended transmission spectrum optimized for 340 nm transmission.

## Faster and more flexible: the reflector turret

Adjustment of the reflector modules to the experiment in question is quicker, saving time, which is an important consideration with the growing diversity of fluorescent proteins. The Axio Observer reflector turret has been optimized in triplicate for this purpose: six filter positions offer more flexibility. Exchanging filter sets without removing the turret bypasses an entire work step. And finally, the Axio Observer turret with position change in under 200 ms is simply faster. With ACR\* the filter modules are read and identified automatically by the system – completely dispensing with the need for configuration on the microscope or in the software. Advantages: faster process and reliable documentation. A perfect solution for the multiuser environment.

\* Automatic Component Recognition. Available for Axio Observer.Z1



## Fluorescence - the operation



Reflector turret: in a matter of seconds, filter sets are now replaced without removing the reflector turret.

Easy to access and to operate: the diaphragm slider for Axio Observer.



## Beam path

- 1 Intermediate image plane/phototube
- 2 Eyepiece
- 3 Intermediate image plane/front port
- 4 Intermediate image plane/base port
- 5 Switching beam path between base port/front port/vis. observation
- 6 Side port prisms
- 7 Tube lens
- 8 Analyzer
- 9 Reflector cube
- 10 Field diaphragm
- 11 Aperture stop
- 12 Filter slider
- 13 HBO lamp
- 14 HAL lamp
- 15 Field diaphragm
- 16 Polarizer
- 17 Aperture stop
- 18 Condenser
- 19 Objective

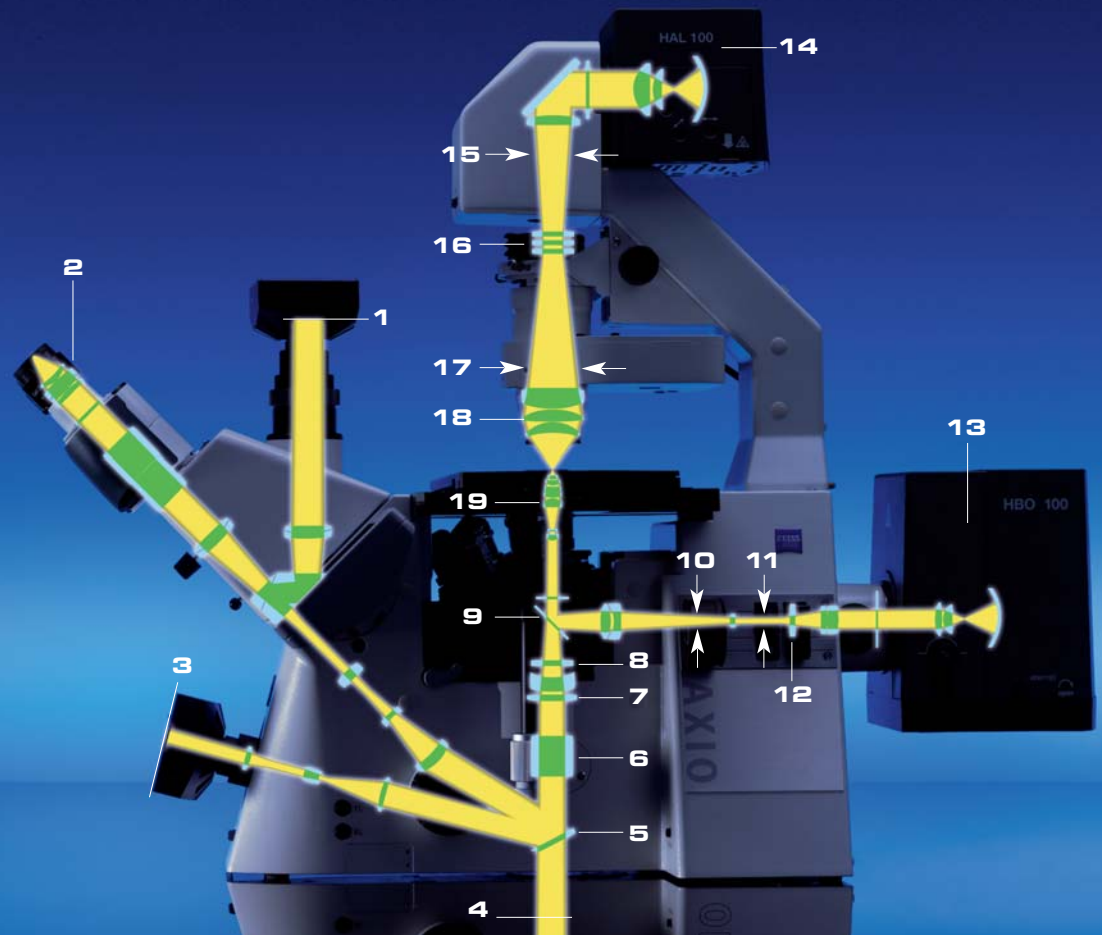

### Diversity for cell observation: the light sources

For Axio Observer, there is the option of a wide spectrum of high-performance light sources. Top on the list is the self-adjusting HBO lamp. This innovative development from Carl Zeiss saves the user the time-consuming task of re-adjustment: it automatically aligns itself and provides a consistently homogeneous illumination of the field of view. In addition, you can also opt for the traditional HBO, or for various durable metal halide lamps, which are coupled via fibers. If you require extremely fast excitation changes in High Speed Imaging (Cell Observer® HS), the xenon-lamp-based light sources, Sutter Lambda DG-4 or Till Polychrome V, can be coupled.

### Standard or high speed: the fluorescence shutters

Two shutters for fluorescence – more options for your experiment. Besides the standard shutter, Axio Observer also features an external, extremely durable high speed variant (5 million switching cycles). Controlled by the camera using trigger pulses, this shutter only opens immediately prior to image acquisition. The exposure of the cells is reduced to an absolute minimum. A key component particularly for live cell experiments.

### Self-adjusting HBO

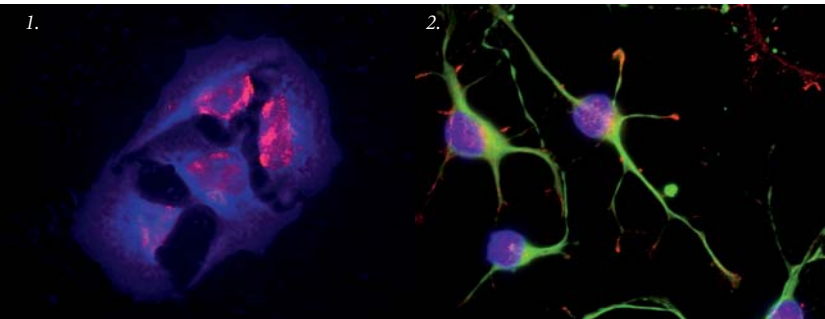

1. Cytoskeleton and nucleus labelled with quantum dots, HeLa cells.
2. Forebrain neurons (rat) cultured on poly-D-lysine/laminin coated glass coverslips. Labelled with DAPI (blue), TUJ1 anti-beta-tubulin (green) and anti-ActR11 (H65) (red). J. Perron, Columbia University, Columbia, USA.

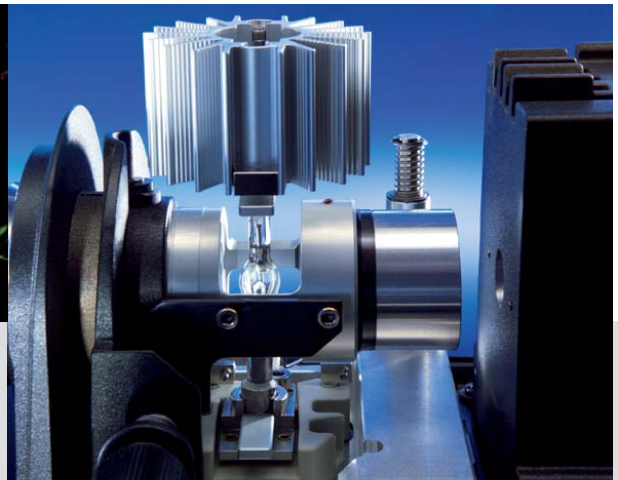

**Variability and reproducibility:  
the diaphragm sliders**

Rectangular diaphragm, FL attenuator\* and iris diaphragm\*: the three diaphragm sliders demonstrate the versatility of Axio Observer in Live Cell Imaging. When used in combination with a motorized iris diaphragm and FL attenuator, Axio Observer reaches a high degree of motorization in the fluorescence beam path. The motorized FL attenuator automatically sets the desired fluorescence intensity, depending on the filter set and objective.

\* Available as a mechanical or motorized option

**Brilliant development:  
the high-efficiency filter sets**

Up to 50% shorter exposure times – the high efficiency (HE) fluorescence filters offer a significantly improved signal to noise ratio and provide gentler fluorescence imaging of living cells. The increased transmission during excitation and emission, together with extremely steep edges, leads to a clear signal separation and optimum yield.

**Diaphragm sliders**

*Numerous options for your individual workstation:  
the manual or motorized diaphragm sliders.*



**Push&Click**

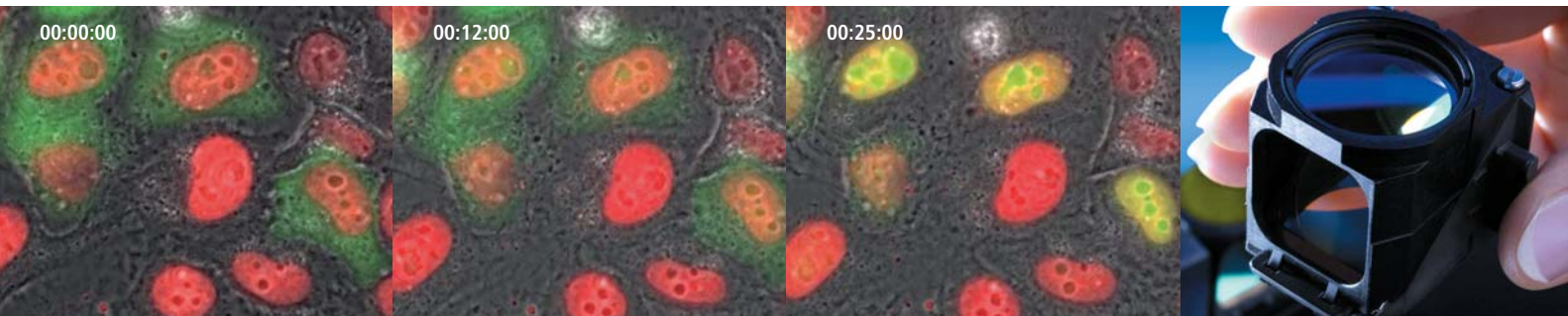

*HeLa cells expressing Histone-2B-DsRed (red), transfected with HIV-1-REV-YEP (green). Background: phase contrast. After treatment with Leptomycine B the Rev-protein accumulates in the nucleus. H. Wolff, GSF Institute for Molecular Virology, Neuherberg, Germany.*



## Who Re-thinks the Workflow When Applications are Becoming Increasingly Complex?

The days when microscopes only differed in terms of optical performance are long gone. The complexity of current applications in all areas of Life Sciences makes ease of use a factor for the success of research work. The challenge for Carl Zeiss is to revise the workflow from planning to monitoring and analysis and to combine it with an intelligent operating concept. Axio Observer now defines the benchmark for ease of operation and efficiency. A must if the immense performance potential of this high-end platform is to be exploited quickly and economically.

### Recognizable increase in convenience: TFT and LCD

Input and monitoring station at the same time – the touch screen TFT display for the motorized Axio Observer.Z1 stand is opening up a new dimension in automated operation. Control and monitoring have been merged radically. The result is unique: the entire microscope can be operated using an extremely short and clear menu guide, which is also valid for the incubation components that control the cultivation conditions. You are sure to be impressed by the ability to trigger activation of the contrast manager or of

the full range of personal user settings on the PC with the tip of your finger. For the D1 stand, a new LCD display has been developed with comprehensive status presentation. Chosen objective, shutter position, etc.: all the settings can be viewed with one quick upward glance. The LCD is also a considerable help with system configuration.

### Freedom to operate: the docking station

A space-saving and immensely practical solution if you operate the system directly from the PC. The Axio Observer docking station gives you access to the complete menu guide of the TFT as well as all the control elements for sample positioning\*. The control elements are identical to the elements located on the stand – no need to switch to different types of buttons. The merging of all the control elements into one compact unit represents a significant advantage, particularly with complex system accessories.

\* In conjunction with the CAN scanning stage

TFT display



Docking station



The TFT display on the stand or in the docking station provides a transparent menu guide for control and configuration.

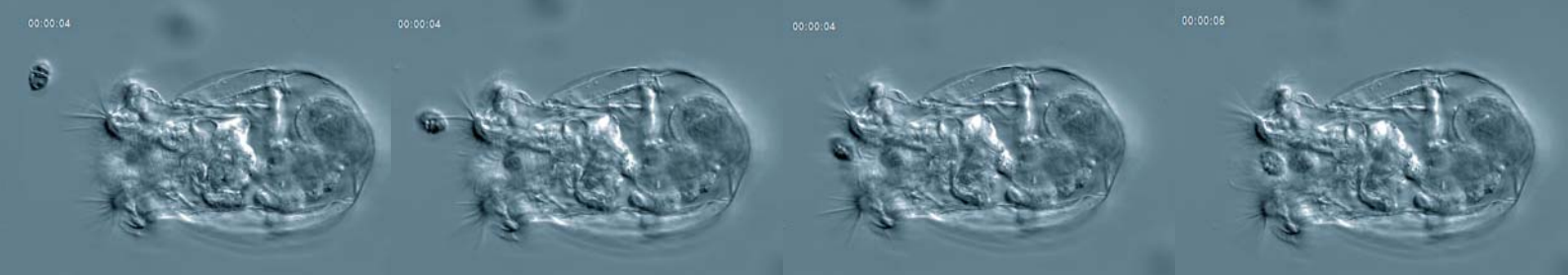

Zooplankton (*Brachionus plicatilis*) feed on phytoplankton (*Heterocapsa triquetra*).  
A. Hagiwara, T. Oda, Faculty of Fisheries, Nagasaki University, Nagasaki, Japan.

**Small details with a big impact:  
the manual control elements**

You notice the difference as soon as you touch them: the control elements of Axio Observer are well thought-out, more intelligent and simpler than anything you have ever known. The buttons in the “keyring” can be reached without taking your hand off the z-drive. They can also be freely configured\* and operated without looking. You can control the entire microscope with ease – without taking your eyes off the eyepiece. The wheels for controlling the intensity of the illumination and opening the field diaphragm in transmitted light enable very sensitive operation and therefore perfect adjustment to the specimen in question. Graphics on the stand and in the TFT display help you to reach your goal more easily and with greater speed.

\* For D1 with PC only

*A chip makes the crucial difference. All the filter sets and objectives are available in a version for Automatic Component Recognition ACR.*

**You make the change,  
who configures it? ACR**

**Automatic Component Recognition ACR** stands for the innovative concept of automatic recognition of objectives and reflector modules from Carl Zeiss. This optional additional component for Axio Observer.Z1 monitors newly inserted filter sets and objectives and adopts them into the system configuration automatically. This saves you time, reduces the risk of error and provides greater convenience – both in everyday microscopy when changing filter sets and during the joint use of filter sets on several stands. A perfect solution for the multiuser environment.

**Simply more efficient: the contrast combinations in transmitted light**

One objective, three techniques, more information in less time: the contrast combinations in transmitted light have been expanded further for Axio Observer. PlasDIC & Phase & DIC or negative Phase & positive Phase & DIC with one objective are examples of how you can obtain more information and varied information about your sample, or simply gain flexibility for different applications with great efficiency.

**Automatic Component Recognition ACR**



# Workflow

## **Automatic in the chosen contrast: the contrast manager**

A perceptible plus in your workflow. You choose the contrast or contrast combination, and the stand ensures the correct setting for the necessary components, even if you change the magnification. This proves to be a pleasant and extremely time-saving feature, particularly for direct observation, since it eliminates several previously required adjustment steps.

## **Transmitted and reflected light regulated well: the light manager**

The Axio Observer generation of light manager offers more than just effective protection against excessively high light intensities in transmitted light. It correctly adjusts the light intensity during a change in magnification both in transmitted light and in reflected light. The fluorescence channels are also taken into account, and the intensity is adjusted accordingly. For cells, this means additional protection against high excitation intensity. This also makes direct observation more pleasant and less tiring for your eyes.

## **Staying relaxed for longer: the ergotube**

The solution for long hours using the microscope. With 50 mm height adjustment and a fixed viewing angle of 25° (which is ergonomically ideal), the ergotube for Axio Observer satisfies the highest standards in terms of comfort; allowing you to adopt a relaxed posture, even during direct observation for several hours.

*With the docking station, the familiar control elements for controlling the microscope are located right next to your PC.*

**LCD**



**Ergotube**

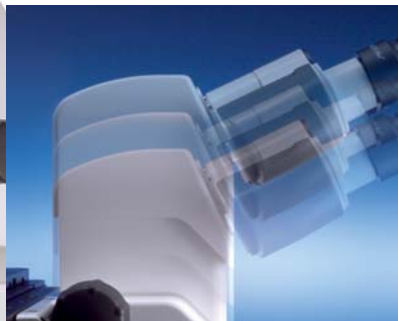

**z-drive with keyring**



*LCD display, ergotube or keyring: the entire Axio Observer operating concept has been designed for quick and convenient workflow.*



# What Does the Quantum Leap in Cell Incubation Bring?

Axio Observer signals the dawn of a new era in cell incubation. One in which temperature, CO<sub>2</sub>, O<sub>2</sub> and air humidity are firmly under control. A significant leap forward in performance with trend-setting innovations. The most notable of these being the full integration into AxioVision. This means that the entire progression of environmental data is documented directly with the image acquisition, significantly improving the reliability of the temperature conditions during analysis of the experiment. Dynamic experiments (temperature levels) are now freely programmable. For example, you can characterize protein mutants that are sensitive to temperature and perform heat-shock experiments.

## Better in every regard: cell incubation from Carl Zeiss

- **The new stack concept for the control modules**

Saving an impressive amount of space and providing maximum effectiveness during the preparation of environment parameters.

- **The new PM S1 incubator**

For improved incubation conditions with extremely small volume for reduced airflow and significant space saving. Compatible with Petri dishes and multiwell plates. There is also a variant available for micromanipulation in a CO<sub>2</sub> atmosphere.

- **The seamless integration into the TFT operating concept and AxioVision**

Ideal for brand new experiment guides. Clear monitoring of the environment parameters enables a quick overview and increased reliability. A particularly important feature is the ability to store the experiment guide and retrieve it again at any time.

- **The component upgrade and retrofit concept**

Greatly simplified and even more flexible: one of many examples is the easily upgradeable O<sub>2</sub> module for reducing the O<sub>2</sub> concentration.

## PM S1 incubator

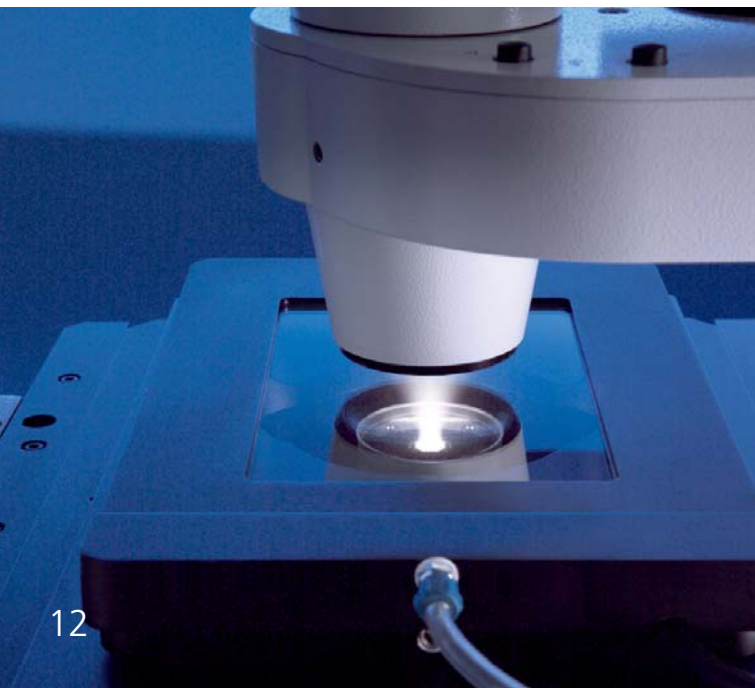

*With thermally-insulated objectives, an insulation ring blocks the temperature flow.*



*Optimum incubation conditions, more space: the PM S1 incubator for Petri dishes and multiwell plates.*

# Incubation

- **The control sensor for measuring temperature directly inside the cultivation dish**

For the first time you can measure the temperature at the observation location precisely, thereby validating your experiment. A major plus, e.g. in dynamic temperature experiments.

- **The thermally-insulated objectives**

For optimized temperature at the sample location and dynamic temperature experiments.

The innovative Carl Zeiss principle: reduction in the quantity of material for heating or cooling – the temperature flow to the rear of the objective and to the objective nosepiece is effectively interrupted. A further advantage is that with experiments involving cooling there is no need for any measures to prevent condensation on the rearmost objective lens. The cold does not reach that far in the first place.

- **The flexibility of two concepts**

Electric heating or flow-induced heating/cooling. The flow principle is also recommended in electrophysiology as it eliminates disturbing influences based on electronics.

## **Big in every respect: the incubators**

Developed specifically for the wide-range of Cell Biology and Pharmacology applications, the Carl Zeiss incubation generation spans a wide range of different models. From the compact PM S1 incubator for maximum freedom to operate to the large incubators of the XL S1 category and their special DARK, TIRF and LSM versions. These are joined by various models for micromanipulation in a CO<sub>2</sub> atmosphere, offering optimum flexibility. The same applies to the operating concept: with Axio Observer.Z1 the entire incubation can be controlled via the TFT display, or optionally via the PC.

## **Keeping everything dry:**

### **Aqua Stop II**

Effective microscope protection with absolute freedom to operate: Aqua Stop II for Axio Observer has been perfectly adapted to the microscope components, and is now even more reliable thanks to comprehensive protection and optimized assembly. If you change Petri dishes on a regular basis or conduct perfusion experiments, Aqua Stop II is really a must, to protect sensitive components, such as filter sets, analyzers and the beam path, against dirt and fluid spills.

## **XL S1 incubator**



*The XL S1 incubator provides peak stability.*

## **Aqua Stop II**



*The Aqua Stop II – perfect safety concept for Axio Observer.*

# How Does a Cell Research Station Grow With Your Requirements?

Never before has the integration of microscope, software and external components reached such a high level of performance. And never before have systems for observing, manipulating and analyzing been so flexible. The advanced architecture of Axio Observer opens the system up to the unlimited integration of external components, turning the innovative cell research stations from Carl Zeiss into solutions that you can also use to realize any demanding applications that lie just around the corner.

## **Modular intelligence: documentation with AxioVision**

Developed in order to make even complex applications with living cells economical, the microscope software from Carl Zeiss is setting the standards in user guidance, individualization and range of performance. From the basic to the most sophisticated package, AxioVision literally grows as your tasks dictate. Module by module. For multidimensional image acquisition, e.g. with Multichannel, Time Lapse,

Z-stack or Mark&Find. Even the basic package can handle dynamic temperature experiments.

## **Targeting the result more purposefully: analysis with AxioVision**

The most demanding tasks simplified intelligently – the analysis modules of AxioVision offer the most technically advanced solution for almost any application. They can also be used in ongoing experiments. For example, the Physiology module undertakes the intensity comparison within the channels in defined regions (ROI) including the graphical representation. There are also numerous other modules available to you with AxioVision – for instance, standard intensity measurements or position analysis of different fluorophores (colocalization). Even if the aim is to allocate emissions to fluorophores (Unmixing), or for intelligent time lapse processing, including the display of moving object regions with details of speed and acceleration.

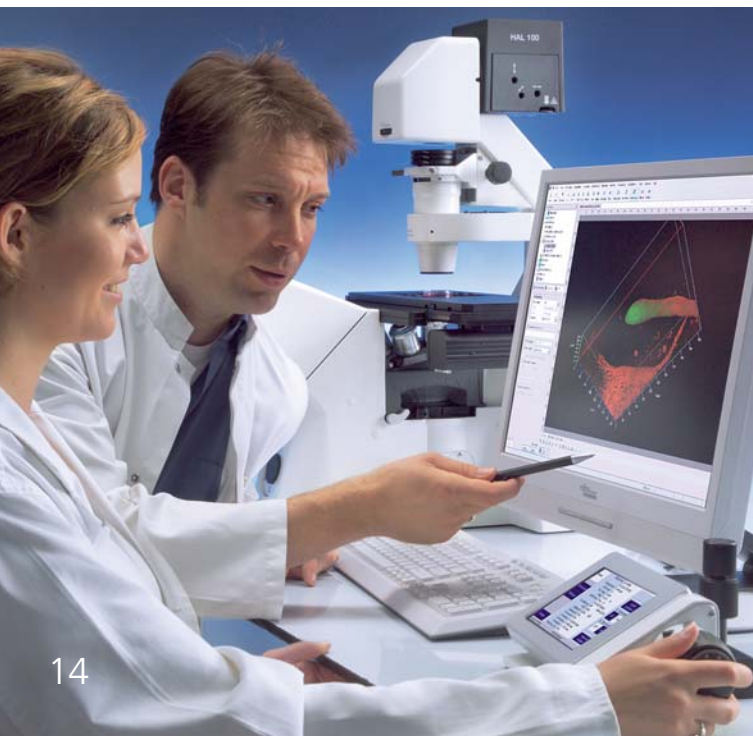

**AxioCam**

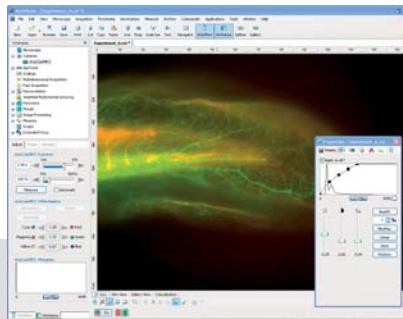



# Integrated System

## Seeing and documenting: the Carl Zeiss blues

Carl Zeiss cameras are recommended in all performance classes – particularly in monochrome for fluorescence imaging. There is the AxioCam HRm with its extremely high resolution in 14 bit dynamics, the AxioCam MRm with its high sensitivity and diverse range of uses, and the AxioCam HSm, which transfers moving images to the hard drive in real time with up to 360 images per second\*. One thing that all models have in common is providing you with perfectly integrated camera technology that optimally supports your system's performance.

## Everything you want for Live Cell Imaging, right through to high speed: Cell Observer®

Cell Observer® has long been the established complete solution in Live Cell Imaging. The new Cell Observer® HS (High Speed) option has been perfected for the documentation of quick processes and long-period observation in Live Cell Imaging. It is particularly useful for calcium studies, cilia movements, vesicle transport and the emergence of microtubuli – i.e. highly dynamic processes that place extreme demands on the entire system. All the elements of Cell Observer® HS are controlled directly using hardware triggers, so

\* With 5x5 binning, full camera field of view

there is no delay. With perfect coordination, every single component – microscope, camera, light source, shutter and focusing system – is optimized for maximum speed. Often a logical addition to the high-speed system is the AxioVision Physiology module for calculating emission intensities (ratio experiments).

## Superb optical sections:

### ApoTome

The solution for the glare-free 3D Imaging of thick samples and tissue sections. ApoTome impresses with outstanding image quality and a conceivably simple operating concept. Available to the Axio Observer D1 and Z1 stands, the microscope insert is simply installed in the plane of the field diaphragm of the reflected light beam path. The principle of grid projection is used to create precise optical sections online, with increased contrast and greatly improved axial resolution.

### LSM Duo

*Satisfying even the highest demands of confocal microscopy: the combination of LSM Meta and LSM Live leaves no wishes unfulfilled.*

### ApoTome

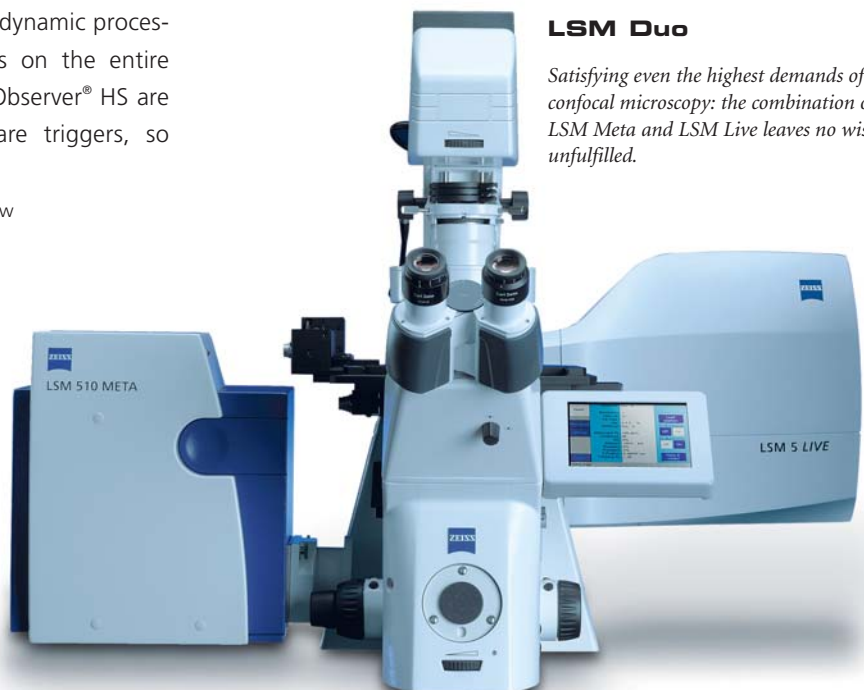



0:00 2:45 3:00

*Hormone-induced gene expression in HeLa cells. The mRFP-marked protein (yellow) is hormonally induced, and in turn induces the expression of the YFP-marked reporter protein (blue).*

*H. Wolff, GSF Institute of Molecular Virology, Neuherberg, Germany.*

### At the high-end of 3D: the LSM systems

Unsurpassed in spectral resolution, temporal resolution and sensitivity: the laser scanning systems from Carl Zeiss embody high-end technology enabling you to look into the depth of your cells. LSM 510 META even records the spectral signature of every single pixel – for perfect unmixing. LSM 5 LIVE, with > 100 frames/sec., adds a new dimension to the scan speed – and with even greater sensitivity. Ideal for observing transport processes in cells and organisms, e.g. the movement of blood cells in the vascular system or the change in dendritic spines on neurons. LSM 510 NLO, with its multiphoton excitation, makes it possible to penetrate into the specimen to unprecedented depths – with several 100 µm as an ideal prerequisite.

### Highly pure samples for exact results: PALM MicroBeam

Enormously versatile and 100% contact-free for the isolation of extremely small tissue samples, such as chromosomes, organelles, cells or small organisms: PALM MicroBeam is the solution for **L**aser **M**icrodissection and **P**ressure **C**atapulting (LMPC), combining laser microdissection with transport by laser light for the first time ever. This

unique, patented technique enables you to cut and remove analysis material without ever touching the sample. Because the technique is contact-free, and therefore also contamination-free, you obtain the purest, clearly defined sample material for all types of downstream processes from genetic analysis to the cultivation of insulated cells. In DNA and RNA appraisal, protein analysis and research with living cells, this system offers science new possibilities and perspectives.

### Maximum resolution in the evanescent field: Laser TIRF

Laser TIRF from Carl Zeiss represents new findings relating to transport processes near the membrane or coupled to the membrane. The focus is also on cell-free systems, for studying protein-protein interactions, for example. This compact complete solution for **T**otal **I**nternal **R**eflection **F**luorescence offers top image quality in all wavelengths – without re-adjustment of the TIRF angle. Space-saving approach: the TIRF slider is simply inserted into the field diaphragm. Perfectly conceived, right down to all typical peripherals like the special TIRF incubators with integrated laser safety.

### PALM MicroBeam

### Living cell after laser transport pulse

### TIRF

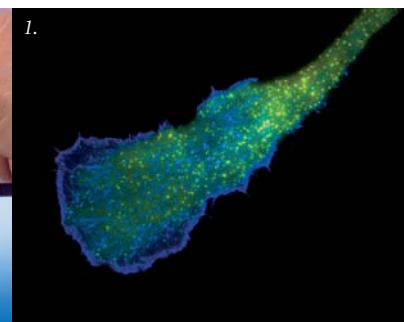
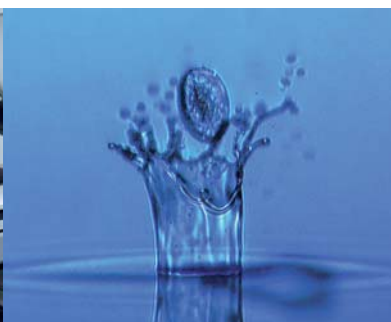

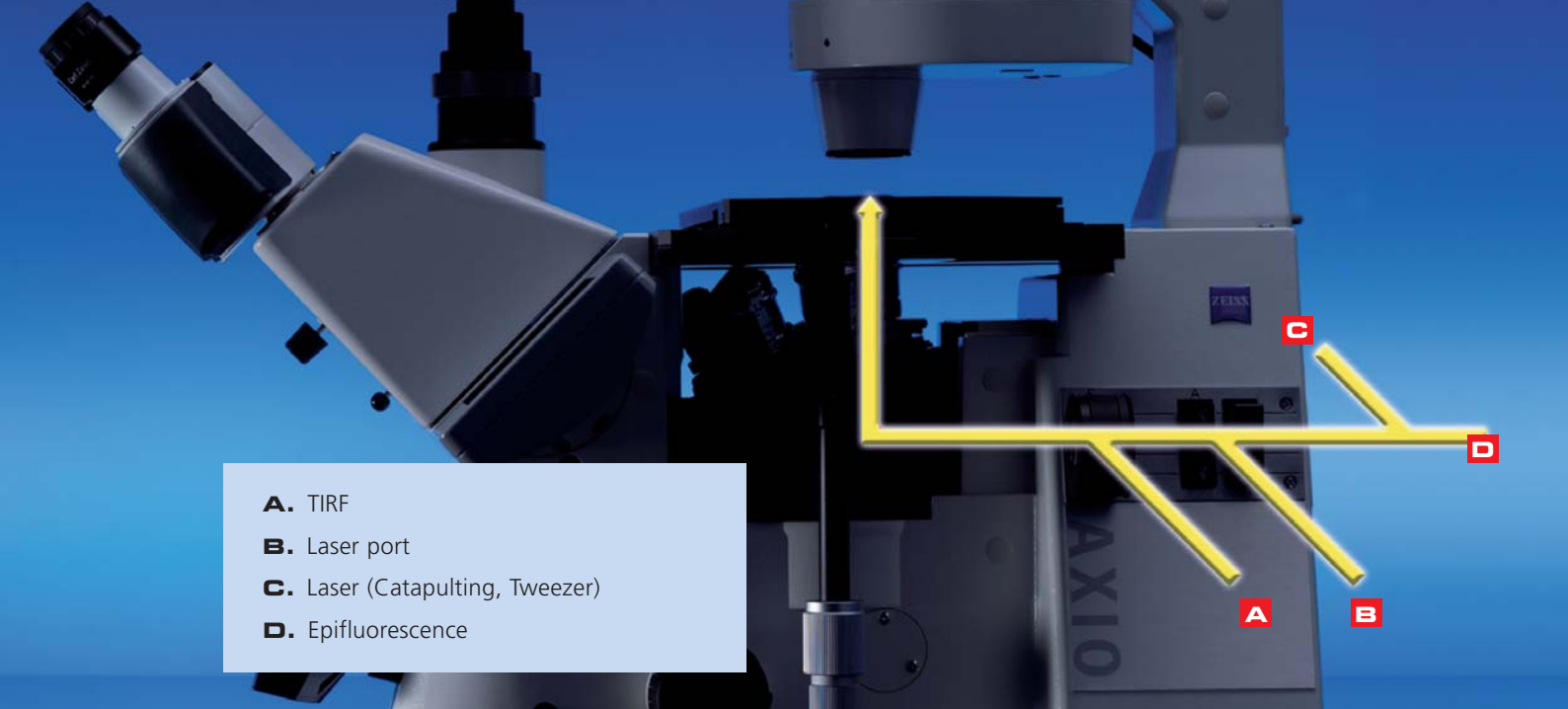

- A.** TIRF
- B.** Laser port
- C.** Laser (Catapulting, Tweezer)
- D.** Epifluorescence

**New flexibility in fluorescence applications: the laser port**

Designed specifically for demanding laser applications such as FRAP, Uncaging, or for the targeted ablation of cellular structures: the laser port for Axio Observer. A receptacle for your own coupling solution. It enables you to work simultaneously with reflected light fluorescence, to change to TIRF applications quickly. It provides new flexibility in the application – without the need to extend the infinity beam path, and without compromising optical quality in any way.

**Basis for higher success rates: Axio Observer in micromanipulation**

Axio Observer is the perfect platform for stem cells or In-vitro-Fertilization (IVF). The extremely high stability and wide-ranging mounting options for manipulators is PlasDIC, the innovative relief contrast ideally designed for the implementation of Intracytoplasmic Sperm Injection (ICSI). With impressive quality and ease of operation, it is already in use in a number of IVF laboratories. If your applications require it, the optimized traditional DIC, with the highest resolution of detail, is ideal for improved success rates, e.g. in sperm assessment and embryo viability. A further important detail is the Thermo Plate glass mounting frame, which ensures homogeneous distribution of temperature on the culture plate. The entire surface of the stage is perfectly flat, making handling of the culture dishes simple and safe.

**Micromanipulation - Eppendorf**



**Micromanipulation - Narishige**





# Why Is The Basis for All Cell Research Systems More Than a Microscope Stand?

The demands on a research microscope in Life Sciences are as varied as the applications. The Axio Observer expansion concept is designed to meet that. There are three stands designed for different application focal points. This concept is essential if you want to realize any system solution economically with Axio Observer.

## Three options offer more freedom to make decisions: the stand types

From the economic starter in the research category to the high-end dimensions of Live Cell Imaging: the Axio Observer stand concept gives you the freedom to choose a stand that suits your requirements and budget. Whatever your decision, you will be getting a high-performance microscope for a reasonable price.

- **Axio Observer.A1:** for demanding routine tasks in Live Cell Imaging and particularly ideal for micromanipulation. The manual stand offers the same high optical quality as the other types.
- **Axio Observer.D1:** greater ease of operation, more flexibility. The D1 stand enables motorized selection of reflector turret, condenser and fluorescence beam path.
- **Axio Observer.Z1:** this stand, the height of perfection in inverse research microscopy, currently offers the very best in terms of ease of operation and flexibility for automated online experiments.

## Axio Observer: three stands, three operating concepts

### Axio Observer.A1

*The basic solution for manual operation*

### Axio Observer.D1

*Above standard: semi-motorized with a freely configurable "keyring"\*, LCD display and light manager*

*\* With PC only*

### Axio Observer.Z1

*Optimum convenience: fully motorized with two freely configurable keyrings, TFT display on the stand or in the docking station, light manager and contrast manager*



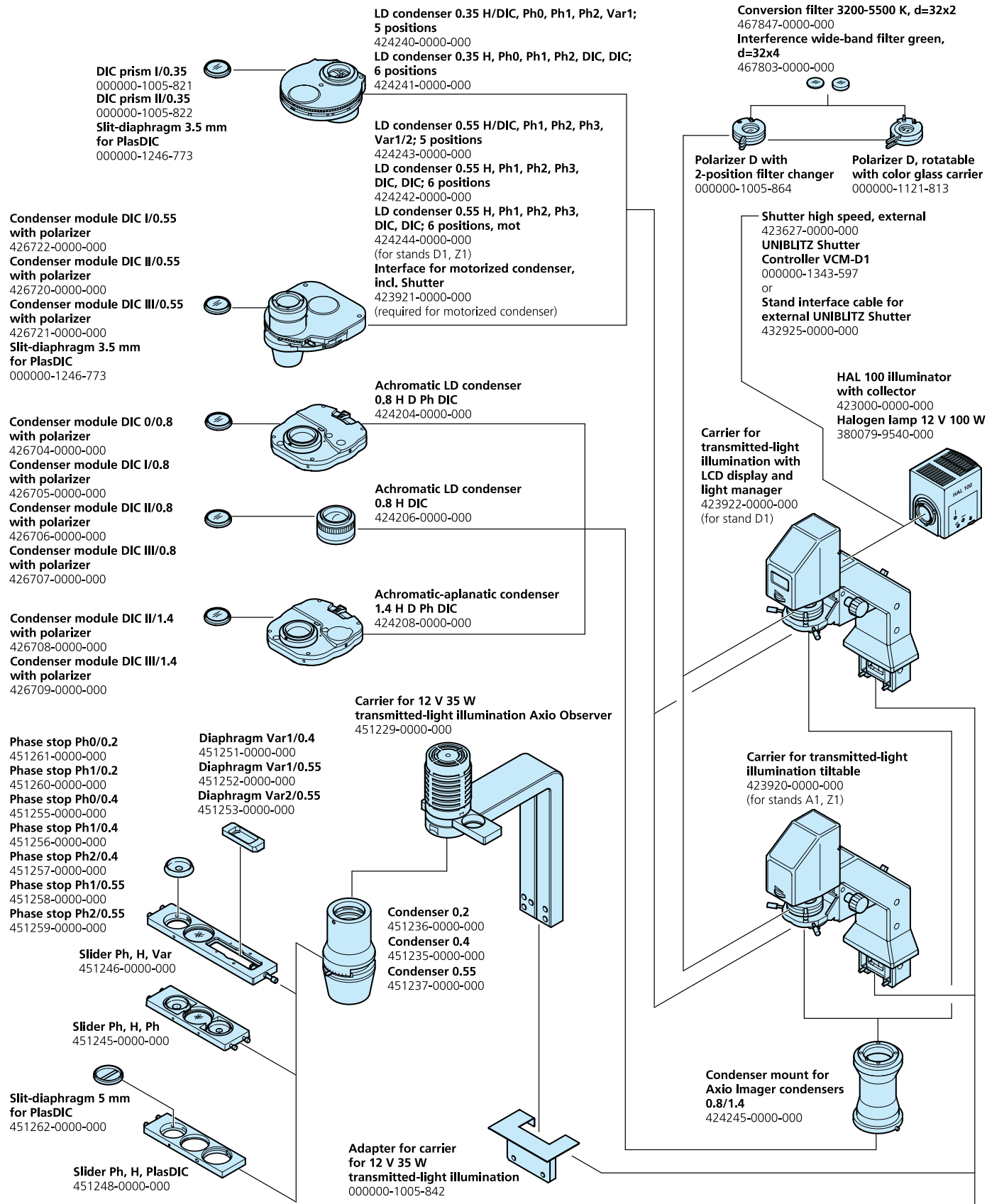

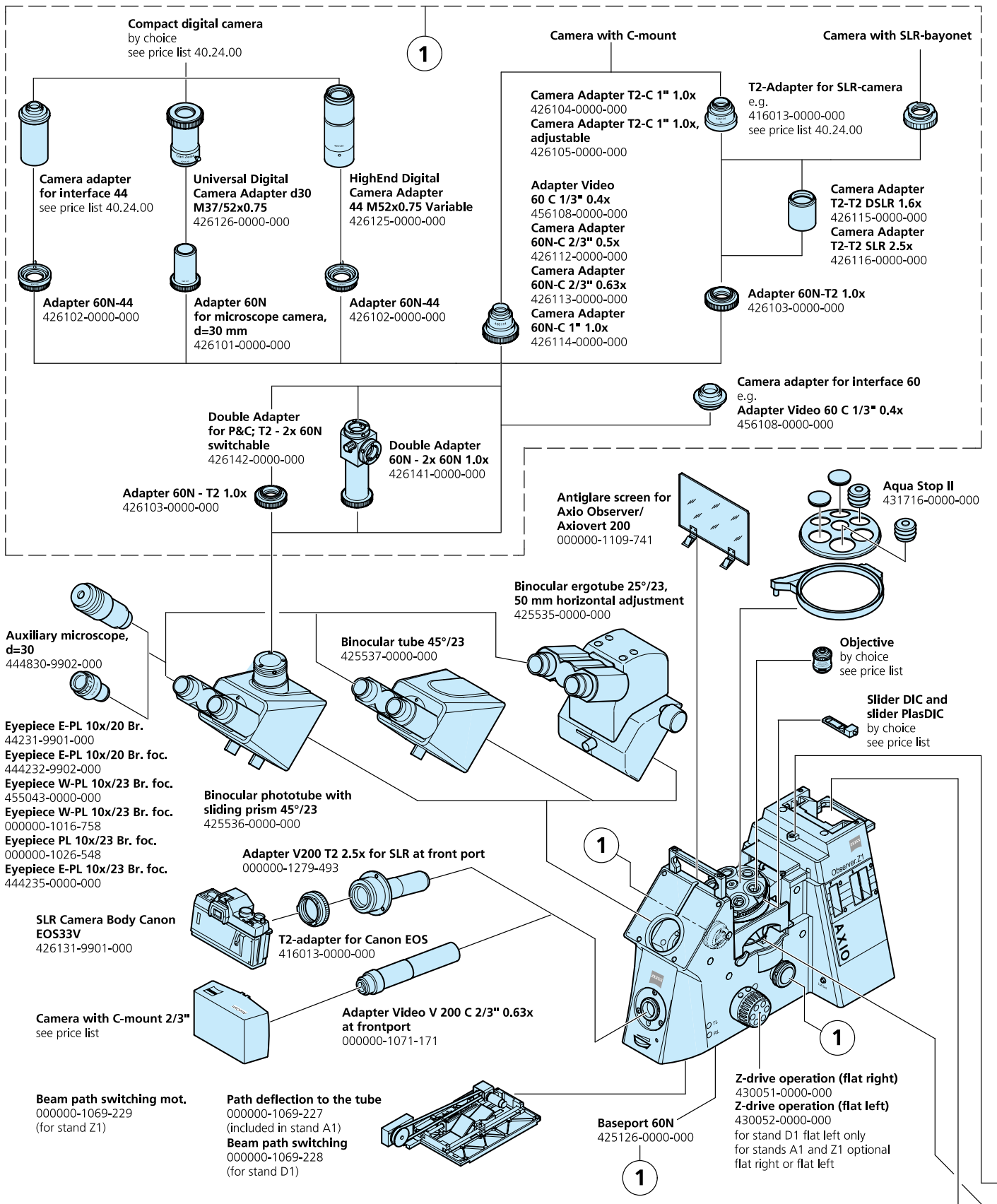



**Mounting frame M for specimen slider**  
76x26 mm  
471719-0000-000  
**Mounting frame M for microtest plates**  
60, 72 and 120 positions  
471747-0000-000

**Mounting frame M for Petri dishes,**  
dia. 36 mm  
471742-0000-000  
**Mounting frame M for Petri dishes,**  
dia. 54 mm  
471743-0000-000  
**Mounting frame M for Petri dishes,**  
dia. 65 mm  
471758-0000-000  
**Mounting frame M for Petri dishes,**  
dia. 88 mm  
471759-0000-000

**Mounting frame M for microtiter**  
plates 96 positions with adhesive scales  
471746-0000-000  
**Mounting frame M for multitest dishes**  
471744-0000-000

**Universal mounting frame M-X**  
471717-0000-000

**Universal mounting frame M**  
471718-0000-000

**Universal mounting frame M-Duo**  
for object guide  
000000-1116-077

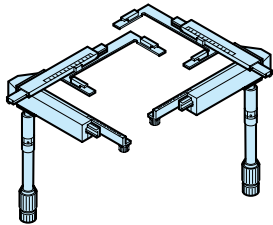

**Object guide**  
130x85 mm left  
000000-1110-991

**Object guide**  
130x85 mm right  
000000-1005-833

**Scanning stage 130x85 mot; CAN**  
432031-0000-000  
**Electronic Coaxial Drive; CAN**  
432904-0000-000  
for stand A1:  
**Converter CAN - USB**  
432909-0000-000  
**PC**  
by choice, see price list

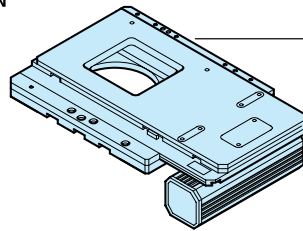

**Mounting Frame K**  
for specimen slider 76x26 mm  
451341-0000-000

**Universal mounting frame K-X**  
451353-0000-000

**Universal mounting frame K**  
451352-0000-000

**Universal mounting frame K-Duo**  
000000-1116-078

**Stage insert**  
by choice  
see price list

**Mounting frame K**  
for reflected light, d=72mm  
451344-0000-000

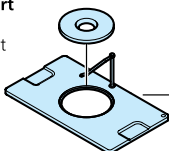

**Mechanical stage 130x85 R/L**  
without mounting frames  
432016-0000-000  
**Mechanical stage 130x85 R/L**  
with short coaxial drive  
without mounting frame  
432047-0000-000

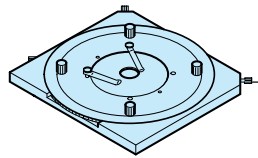
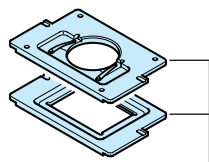
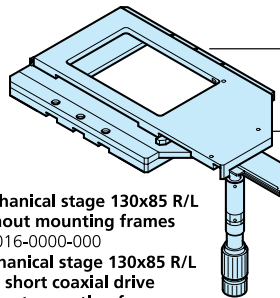

**Gliding stage Z with**  
stage inserts d=24 and 48mm  
471722-0000-000

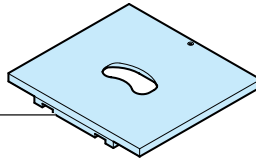
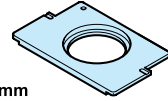

**Specimen stage 250x230 mm**  
432017-0000-000

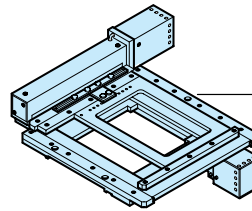
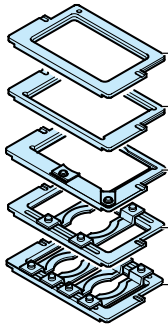

**Scanning stage 120x100 STEP**  
432029-0000-000  
with  
**Ludl MAC5000 XY Stage**  
**Controller Stepper**  
incl. Joystick  
000000-0431-478  
**Ludl Stepper Motor Cable**  
with Right Angled Plug  
(2x)  
000000-0445-551

**Coverglass cap**  
D = 0.17 - 0.6 mm  
422902-9901-000

**ACR rings**  
by choice  
(for stand Z1)

**Objectives W 0,8**  
by choice  
see price list

**Objectives M27**  
by choice  
see price list

**DIC/PlasDIC**  
slider  
by choice  
see price list

**Adapter**  
M27x0.75 / W 0.8 H "0"  
000000-1095-168

included in stand A1:  
**6-position objective nosepiece,**  
**H DIC M27 man.**  
(3 DIC positions)

for stand D1:  
**6-position objective nosepiece,**  
**H DIC M27 cod.**  
424526-0000-000

for stand Z1:  
**6-position objective nosepiece,**  
**H DIC M27 mot.**  
424527-0000-000

**6-position objective nosepiece,**  
**H DIC M27 mot. ACR**  
424528-0000-000

**Protection filter**  
for reflector turret  
000000-1068-113

**Reflector modules P&C**  
by choice  
see price list

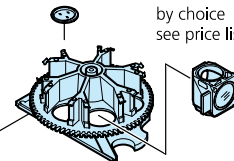

**6-position reflector turret man.**  
for P&C modules  
424945-0000-000

for stands D1, Z1:  
**6-position reflector turret cod.**  
for P&C modules  
424946-0000-000

**6-position reflector turret mot.**  
for P&C modules  
424947-0000-000

**6-position reflector turret mot. ACR**  
for P&C modules  
424948-0000-000

# System Overview

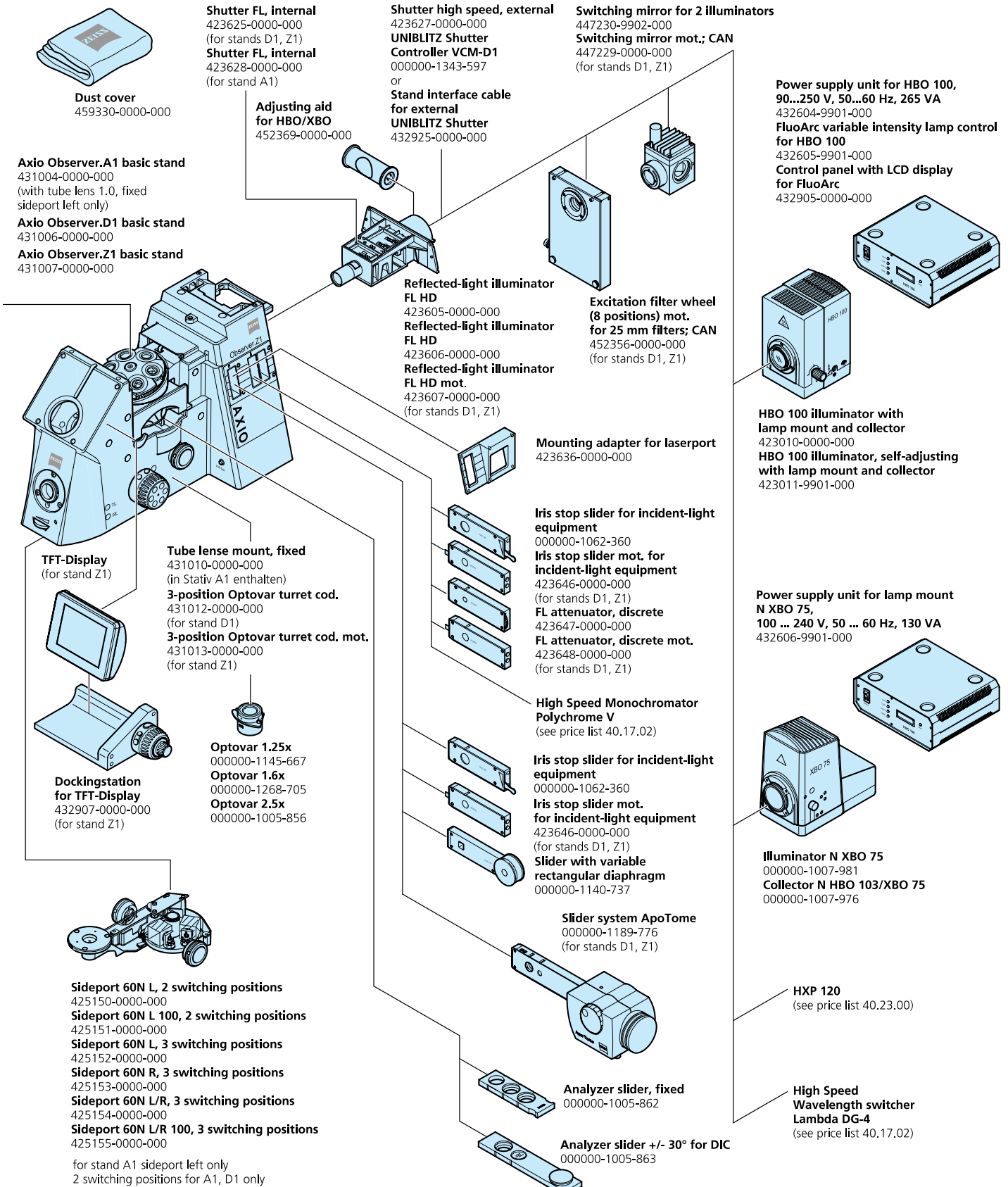

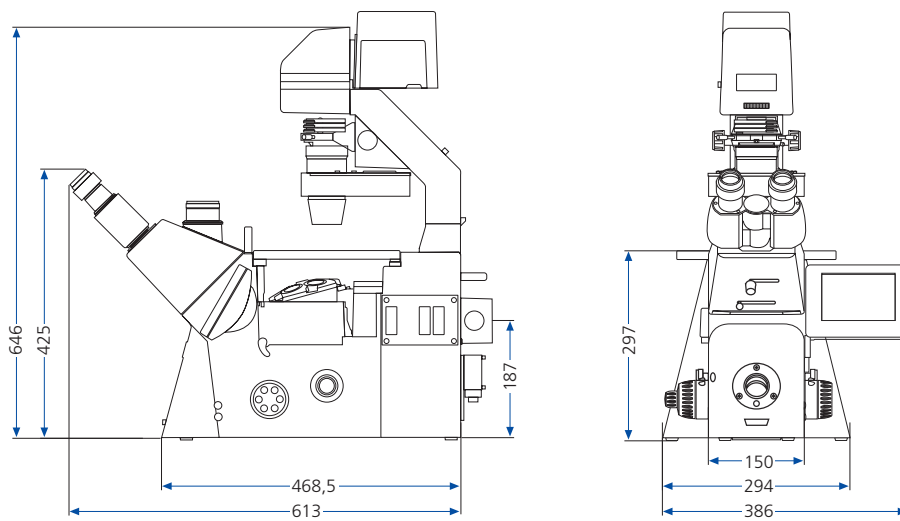

## Axio Observer

Component	Option	A1	D1	Z1
Stand	manual	+	+	-
	motorized	-	0*	+
Coding	readoutable from the stand	-	+	+
Tube lens mount	1x	+	0	0
Optovar nosepiece	3x cod	-	0	-
	3x mot	-	-	0
Objective nosepiece	3x H/3x H DIC man	+	-	-
	6x H DIC cod	-	•	-
	6x H DIC mot	-	-	0
	6x H DIC ACR mot	-	-	0
Reflector turret	6x man	0	0	-
	6x cod	-	0	0
	6x mot	-	0	0
	6x mot ACR	-	0	0
Condenser	N.A. 0.35 man	0	0	0
	N.A. 0.55 man	0	0	0
	N.A. 0.55 mot	-	0	0
	N.A. 0.8 man	0	0	0
	N.A. 1.4 man	0	0	0
Reflected-light beam path	apochromatic man	0	0	0
	apochromatic mot	-	0	0
	UV optimized man	0	0	0
Shutter	fast Uniblitz shutter TL	-	0	0
	standard shutter RL	0	0	0
	fast Uniblitz shutter RL	-	0	0
Diaphragm slider or FL attenuator	man	0	0	0
	mot	-	0	0
Documentation	side port (left)	0	0	0
	side port (right)	-	0	0
	phototube	0	0	0
	base port/front port	-	0	0
z-focus	man	+	+	-
	mot	-	-	+
Display	LCD display	-	+	-
	TFT display	-	-	+
	docking station for TFT	-	-	0
Laser port		-	+	+
Switching mirror for 2 illuminators	man	0	0	0
	mot	-	0	0
Excitation filter wheel		-	0	0
Aqua Stop II		0	0	0
Laser safety facility TIRF/LSM		-	0	0
Imaging	AxioCam/AxioVision	0	0	0
	ApoTome	-	0	0
	Cell Observer®	-	0	0
	TIRF	-	0	0
Confocal	LSM 510	-	-	0
	LSM Exciter	-	-	0
	ConfoCor 2	-	-	0

- = not possible  
+ = included with stand  
o = optional

• = necessary  
\* = optional: reflector turret, condenser and  
fluorescence beam path



# Win-Win Situation

## The microscope

- New flexibility in the inverse research category
- Developed for the observation, manipulation and analysis of living cells

## The optics

- High-performance objectives for the different tasks involved in Live Cell Imaging, with special LCI and thermally-insulated objectives leading the way
- Optimized Differential Interference Contrast for homogeneous illumination across the entire field of view
- Innovative and open to new areas of applications: the combination of positive and negative phase contrast in one objective

## The fluorescence

- Absolute brilliance right into the periphery provided by the newly designed fluorescence beam path
- Achromatic correction for optimum imaging of all wavelengths
- Up to 70% higher excitation intensity due to high-performance filter sets
- Up to 50% shorter exposure times due to HE filter sets
- 6x reflector turret, faster at changing position (< 200 ms) with a new quick change concept for the filter sets
- Versatile illumination spectrum from the self-adjusting HBO to the high-speed light source

## The workflow

- Ease of operation with new dimensions for control and monitoring via TFT display
- Flexible system control via stand, TFT, docking station or PC

- Perceptibly more intelligent in manual operation
- Automatic Component Recognition ACR for objectives and reflector modules
- Simply more efficient due to greater contrast combinations in transmitted light
- Optimally regulated by means of contrast and light management
- Working more relaxed for longer periods of time with the ergotube
- Automated to save time, and greater ease of operation provided by the new shutter concept

## The safety

- Unshakable: the reliable pyramid design
- Effective microscope protection with absolute freedom to operate provided by Aqua Stop II

## The cell research station

- Unique flexibility for any level of application, from routine to high-end
- Superb integration at all system levels
- A new level of performance in cell incubation
- Open system architecture for easy integration of external components

## The system

- Options: Cell Observer® or Cell Observer® HS
- AxioVision imaging software
- TIRF, LSM, Microdissection, laser port for FRAP and Uncaging
- Unique solutions for incubation

## The expansion concept

- Optimum performance economically feasible: the variable expansion concept in three stands
- Designed for different requirements and application focal points
- Growth platform for now and for the future

## Carl Zeiss MicroImaging GmbH

P.O.B. 4041, 37030 Göttingen, Germany

Phone: +49 551 5060 660

Fax: +49 551 5060 464

E-mail: [micro@zeiss.de](mailto:micro@zeiss.de)

[www.zeiss.de/axioobserver](http://www.zeiss.de/axioobserver)